



お問い合わせ窓口 : 株式会社ユーアイ

MAIL:info@ui-vehicle.com
http://www.ui-vehicle.com
TEL:072-363-8913/FAX:072-363-8914
〒587-0063 大阪府堺市美原区大饗158-1

付属品

- ①  専用ナット 28個 +1個(予備) (1パック)
- ②  M6×10L 46個 +1個(予備) (1パック)

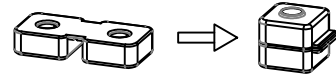

PS: 専用ナットを使用する時は折り曲げる必要があります。

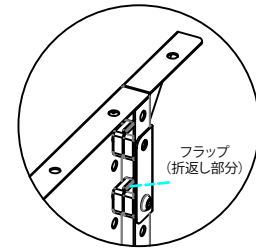

PS: 専用ナットはフラップ(折返し部分)を上又は下の方向に揃えてご利用ください。

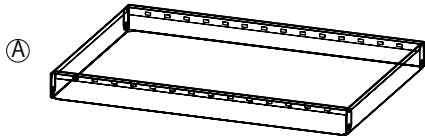

V00004-1 棚 3個

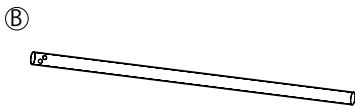

V00004-1 ハンガーバー 19本(B~F)

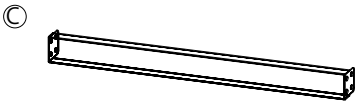

V00004-1 サイトバー 2本(B~F)

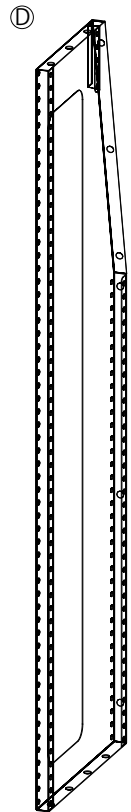

V00004-1 左サイド板 1枚
(B~F)

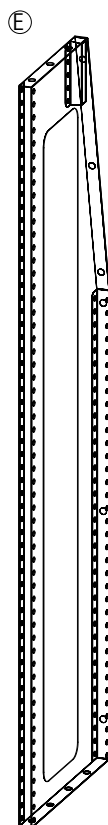

V00004-1 右サイド板 1枚
(B~F)

⑥ V00004-1 ブラケット 2個 (B~F)



①

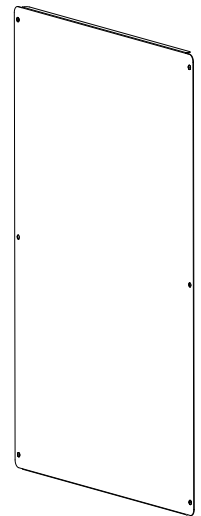

V00004-1 リアパネル下 1枚 (G~I)

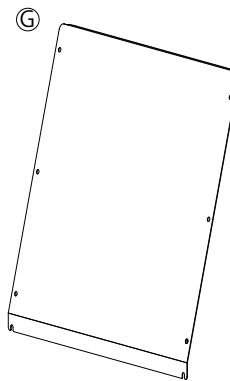

V00004-1 リアパネル上 1枚 (G~I)

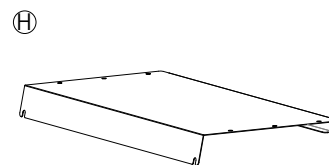

V00004-1 天井パネル上 1枚 (G~I)

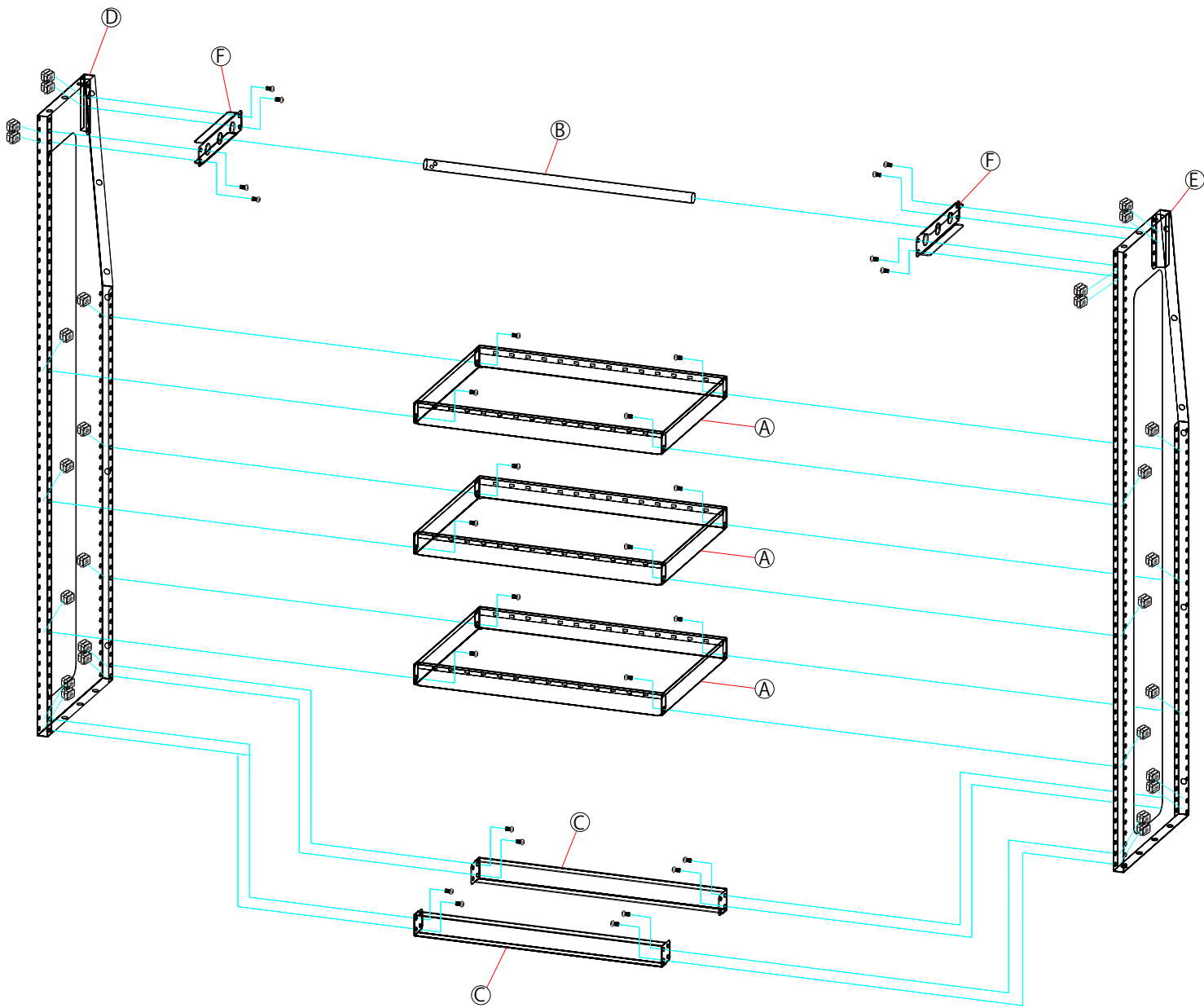

I.G.H

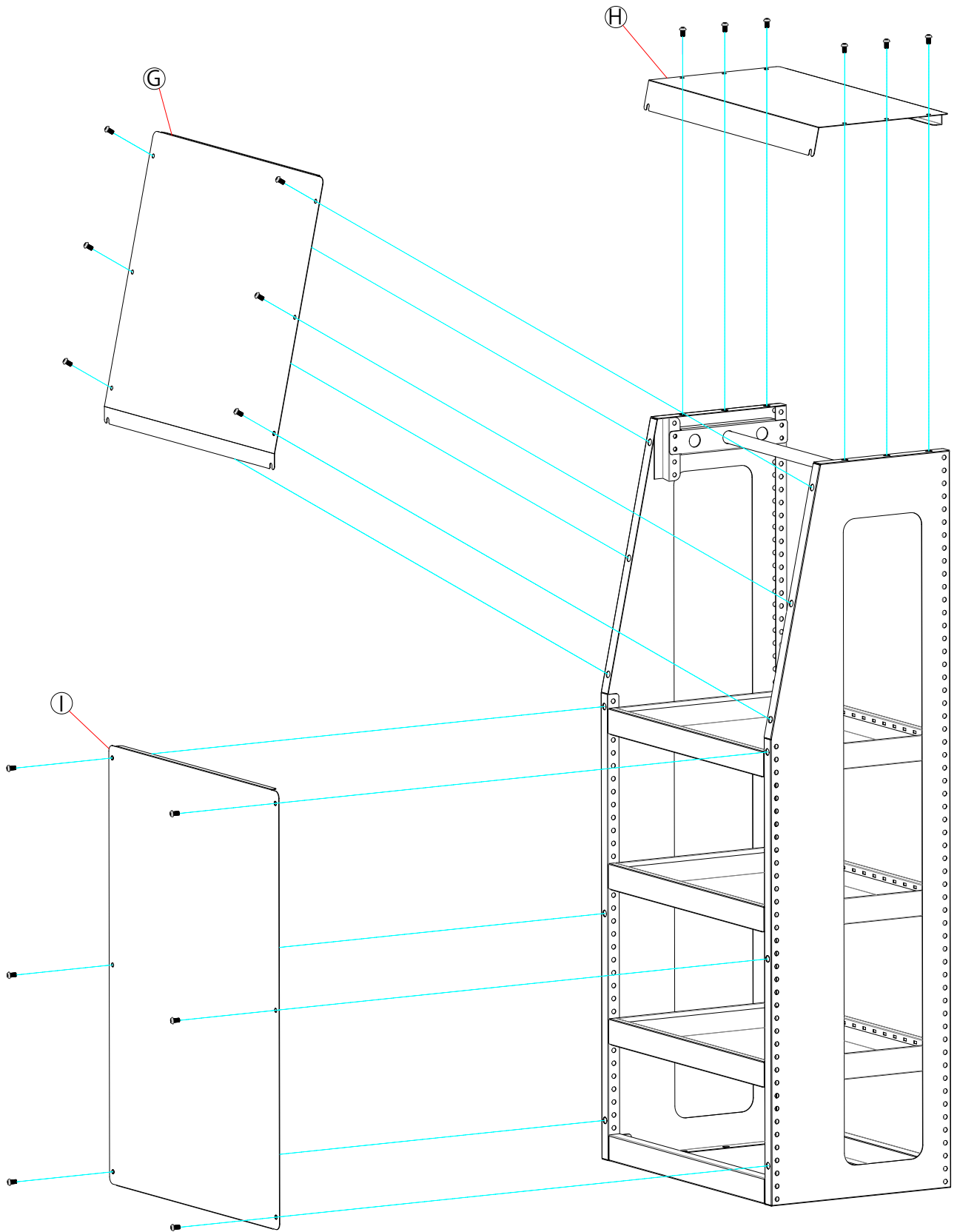

P4