

THANKO

Model number: AWHD25HJU

Operating Instructions

Version 1.00 y

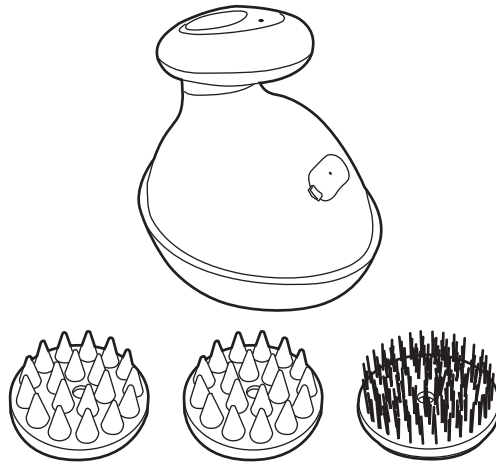

Warranty Period: 12 months from the date of purchase

※ The invoice, receipt, etc. will serve as a warranty.

• SPECIFICATIONS

Size	Main unit: Width: 100mm x Depth: 120mm x Height: 105mm Charging base: Width: 110mm x Depth: 130mm x Height: 45mm
Weight	about 410g
Power Source	Built-in battery
Battery charging	USB (5V 2A or higher)
Battery	Lithium polymer battery 3.7V 1000mAh
Charging time	about 2.5 hours
Operating time	about 40 mins (varies depending on conditions)
Mode	Two types (90/180 degrees)
Auto Power off	5 mins
Tank Capacity	55ml
Waterproof performance	IPx7 (main unit only)
Cable length	about 95cm
Material	ABS, PC, silicone
Package contents	Main unit, charging base, USB Type-C cable, 3 brush types (hard, soft, brushing), brush removal part, Instruction manual
Warranty	12 months from date of purchase

• SAFETY PRECAUTIONS

Please be sure to follow these rules

Please read the "Safety Precautions" carefully before use and be sure to follow them.

※ The items listed here are intended to ensure safe and correct use of the product, and to prevent injury to the user and other people, as well as damage to property. In addition, to indicate the severity and imminence of the hazard or damage, the contents that may result from improper handling are categorized into three categories: "Danger", "Warning" and "Caution". All of these are important safety precautions and must be followed. Please keep this instruction manual in a safe place so that the user can refer to it at any time. If you lend this product to a third party, please lend this manual to them as well, and instruct them to read it carefully before use.

Warning

This indicates that ignoring this warning and handling the product incorrectly may result in death or serious injury.

Do not use in the following cases or areas:

- Areas where plastic surgery has been performed;
- If you have or have any scalp abnormalities such as dermatitis or excessive sunburn;
- If you have or have any scalp wounds, eczema, swelling, or suppurative diseases;
- After drinking alcohol or if you are extremely tired (this may cause injury or physical problems).
- If you experience or feel any physical abnormalities while using this product, discontinue use immediately and consult a doctor. Failure to do so may result in an accident or poor health.

If you are currently receiving medical treatment or if any of the following apply to you, consult a doctor before using this product.

- People with scalp skin conditions such as atopic dermatitis, seborrheic dermatitis, and eczema;
- People with allergies, skin problems or injuries from silicone products;
- People with acute illnesses or malignant tumors;
- People with infectious diseases, paralysis or sensory impairments;
- People with a history of scalp problems from washing their hair;
- People with bleeding disorders, hemophilia, blood disorders and high blood pressure;
- People with a history of eye disease or treatment, osteoporosis;
- People taking medications (anticoagulants or other medications containing ingredients that inhibit blood clotting) (which may cause physical problems or worsen symptoms).

- Use and store out of reach of children and pets. (Risk of accidents and injury)
- Do not use on pets. (Risk of accidents and injury)
- Do not modify or disassemble. Only authorized repair technicians should disassemble or repair this product. (Risk of fire, electric shock, and injury)
- Do not immerse the charging base in water. (This may cause a short circuit, electric shock, or malfunction.)
- If an abnormality occurs with the product, immediately discontinue use. (Continued use while an abnormality occurs may result in smoke, fire, electric shock, leakage, short circuit, or injury.)
- The cable or USB port is swollen, deformed, discolored, or damaged.
- A part of the cable or USB port is hotter than usual.
- Power is switched on and off when the cable is moved.
- The device becomes unusually hot or emits a burning smell.
- The device does not function.
- You hear strange noises.
- If any of the above occurs, immediately discontinue use, turn off the device, and contact your retailer or support center.
- Do not insert metal objects such as pins or wires into the device's gaps. (This may cause a short circuit, electric shock, or malfunction.)
- Do not subject the device to strong impacts or throw it. (This may cause electric shock or injury.)
- Do not plug or unplug the cable with wet hands. (This may cause electric shock.)
- Do not use or store the device in high temperature, humid locations, or in direct sunlight. (Causes deformation, discoloration, smoke, and fire)



Note

This indicates that failure to follow this caution and improper handling could result in injury to persons or damage to property.

- Do not use if you have hair transplants, partial wigs, or extensions. (This may damage the transplanted hair, and cause hair and scalp problems.)
- Do not apply more pressure than necessary, use the product for long periods of time in the same place, or move it quickly. (This may cause injury or malfunction.)
- Do not insert your fingers or other objects into the grooves around the brush while in use. (This may cause injury or malfunction.)
- Always use the product with the brush attached. (This may cause injury or malfunction.)
- Do not pour foreign objects into the shampoo/water inlet. (This may cause injury or malfunction.)
- Do not use for long periods of time. (This may cause injury or malfunction.)
- Do not drop or subject the product to strong impacts. (This may cause damage.)
- Do not use for purposes other than those intended or as described in the instruction manual. (This may cause injury or malfunction.)
- Do not use organic solvents (benzine, thinner, petroleum, etc.), chemicals (bleach, disinfectant, etc.), or abrasives when cleaning. (This may cause discoloration or damage.)

Handling of USB cables

- Do not replace, damage, modify, place near heat sources, bend, twist, pull, place heavy objects on, or bundle the USB plug or USB cable.
- Never replace, disassemble, repair, or modify a damaged USB plug or USB cable.
- Immediately stop charging if the USB plug or USB cable is damaged.
- Make sure the USB plug is fully inserted and do not use a damaged USB plug or USB cable.
- Do not plug in or unplug the USB plug with wet hands.
- Do not leave the USB plug plugged in except when charging.
- Do not pull on the USB cable when carrying or storing the device.
- Do not pinch the USB cable in a device, and do not charge while pulling the USB cable.
- Regularly check that there is no dust accumulation on the device and USB plug.
- Do not charge if the USB plug or USB cable is loose.
- Do not place objects on the USB cable while charging.
- When plugging in or unplugging the USB plug, hold the tip and do not pull on the USB cable.
- If the USB plug or USB cable becomes abnormally hot or gives off smoke or an odd odor while charging, stop using it immediately.
- Do not plug in or unplug the cable with wet hands.
- Do not pull on the cable when carrying or storing.
- Do not pinch the cable in a device or use it while pulling the cable.
- Regularly check that there is no dust buildup on the main unit and USB port.
- Do not use if the USB port or cable is loose.
- Do not place any objects on the cable while in use.
- When plugging in or unplugging from the USB port, hold the tip, do not pull on the cable.
- If the USB port or cable becomes abnormally hot or gives off smoke or an odd odor while in use, stop using it immediately.

Battery charging and storage

- The built-in battery will naturally discharge even if charged and stored, so charge it immediately before or the day before use.
- When charging, charge in an ambient temperature range of 10°C to 30°C (a temperature that humans find comfortable).
- The lower the temperature, the more difficult it is to charge and the more the built-in battery will wear out. Also, high temperatures will prevent full charging.
- The built-in battery may become warm during charging or use, but this is not a malfunction.
- When storing, keep it at approximately 50% charged.
- The built-in battery naturally discharges, so storing it fully discharged may render it unusable.
- Do not store it in high temperatures, over-discharged (fully discharged), or overcharged (leaving the battery connected to the charger even when fully charged).
- Be sure to use it at least once every six months to prevent wear.
- Store it in a dry place between 10°C and 35°C.
- Check the battery charging port and USB port for moisture, metal, or other foreign objects before charging.
- Do not use batteries whose usage time has become extremely short.
- Do not use a battery that has been dropped or damaged in any way. This product has a 300 charge/discharge cycle limit.
- If the operating time becomes shorter or the charge runs out quickly, the battery has reached the end of its life.

Battery recycling



Li-ion

This product contains a built-in lithium-ion battery. This battery is a valuable recyclable resource. When disposing of or recycling used products, please follow the instructions of your local government.

Usage Guidelines

- ※ Items other than those listed are not included.
- ※ Damage to items caused by using this product is not covered by the support warranty.
- ※ If you notice any abnormalities, stop using the product immediately and contact the support center.
- ※ Failures, damage, modifications, etc. caused by customer negligence are not covered by the support warranty.
- ※ We cannot be held responsible for accidents caused by incorrect use.
- ※ The copyright of this document belongs to our company, and unauthorized reproduction of all or part of the contents is prohibited.
- ※ Specifications may be changed without notice for improvement purposes.

• SET CONTENTS AND PART NAMES

Please check that all contents are included.

Main unit

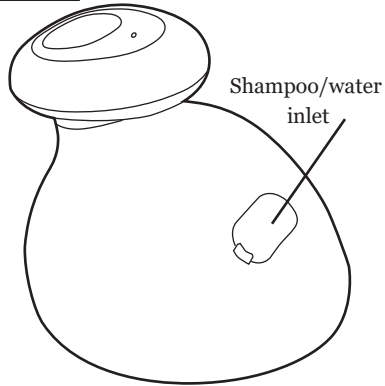

Top

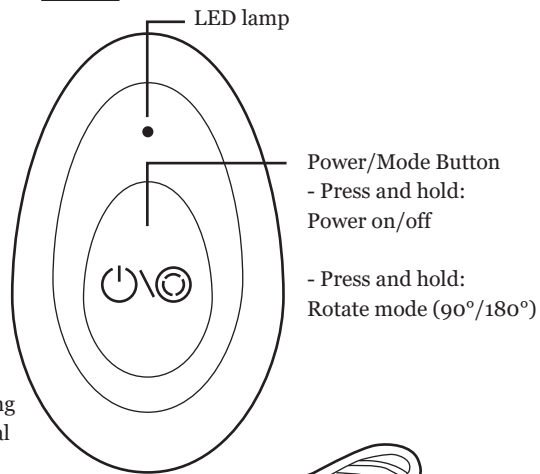

Charging stand

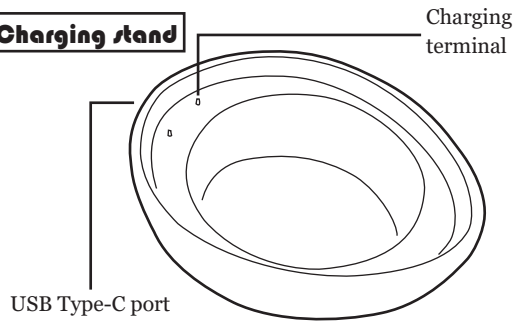

Hard Scalp Brush



Soft Scalp Brush

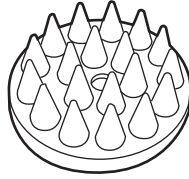

Brushing brush

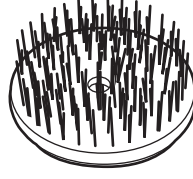

These two types look the same, but on the back they are labeled S (soft skull brush) and H (hard skull brush).

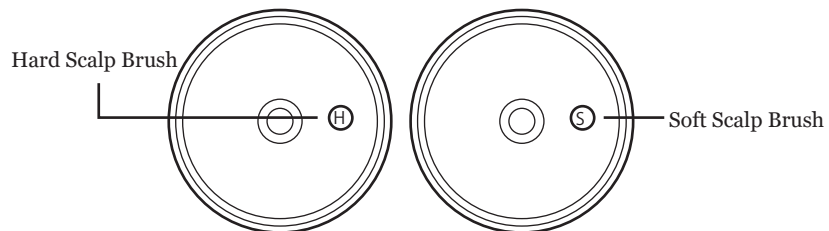

• CHARGING METHOD

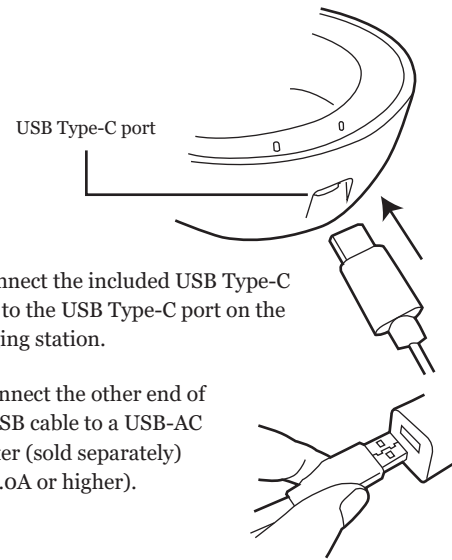

- 1) Connect the included USB Type-C cable to the USB Type-C port on the charging station.
- 2) Connect the other end of the USB cable to a USB-AC adapter (sold separately) (5V 2.0A or higher).

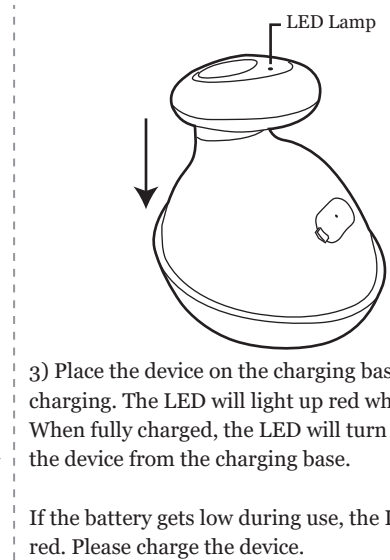

- 3) Place the device on the charging base to begin charging. The LED will light up red while charging. When fully charged, the LED will turn green. Remove the device from the charging base.

If the battery gets low during use, the LED will flash red. Please charge the device.

• BRUSH INSTALLATION/REMOVAL

! Always turn off the power before attaching or removing the brush.

Attachment Align the bumps on the body and brush and push until you hear a click. Make sure the gap between the brush and body is parallel.

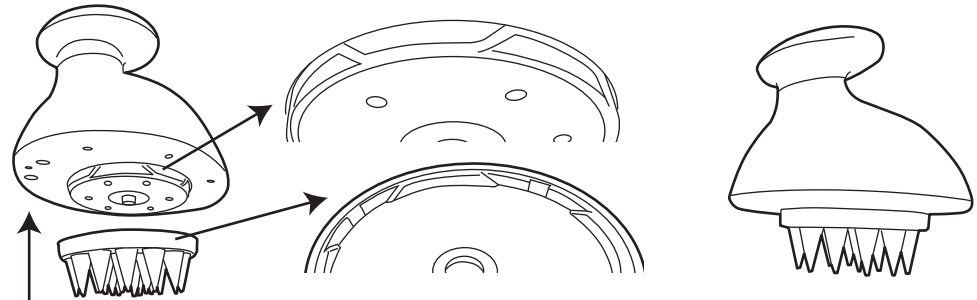

Attachment To remove, insert your finger into the gap between the body and the brush and pull. If it is difficult to remove, insert the tip of the included brush remover into the gap between the body and the brush and remove it.

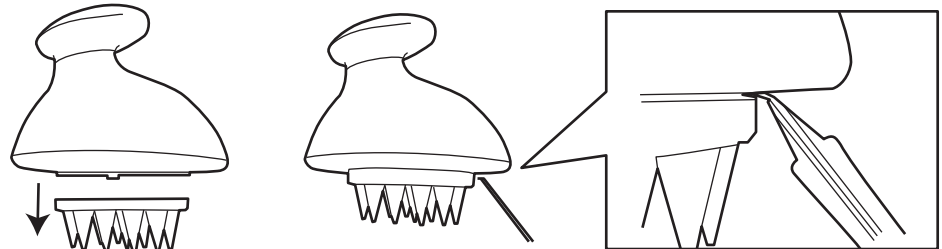

• HOW TO USE

1) Attach the brushing brush to the main body.

2) Comb your hair with the brushing brush to remove dirt. Once the dirt is removed, switch to the scalp brush. Use your preferred scalp brush, whether hard or soft.

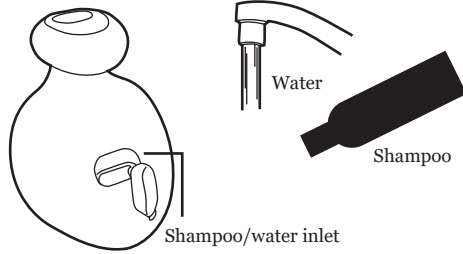

3) Open the shampoo/water inlet cover and add shampoo and water (a 1:1 ratio is recommended). Add the amount of shampoo you normally use. Also, be sure to add water. Lathering will not occur without water.

4) Wet your hair.



5) Press and hold the power/mode button (for about 3 seconds) to turn on the power and start operation. The LED lamp will light up blue.

Briefly press the power/mode button to change the brush rotation angle (90 degrees/180 degrees).

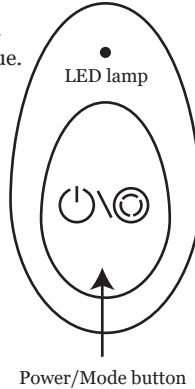

6) Once foam comes out from the centre of the brush, gently press the brush against your hair so that it touches your scalp.

※ The power will automatically turn off after 5 minutes.
 ※ If foaming becomes poor, adding a little water to the shampoo/water inlet may help.



7) When you're done washing, be sure to press and hold the power/mode button to turn the power off.

8) Rinse out the shampoo.

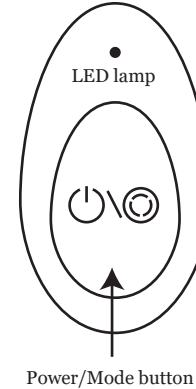

• COLOR OF THE LED LAMP

LED Light	Light Color
Charging	Red Solid
Fully Charged	Green Solid
Low Battery	Red flashing
Power ON	Blue Solid
90° Rotation Mode	Blue flashing
180° Rotation Mode	Blue Solid

• MAINTENANCE



Please perform maintenance with the power turned off.



Do not use benzene, thinner, bleach, scouring powder, alkaline detergent, metal scouring pads, or hard sponges (these may damage the surface).
 Do not immerse the unit in water. This product cannot be disassembled or washed.

• Charging Base

The charging base is not waterproof. Never immerse it in water or get it wet. If the charging base is heavily soiled, apply diluted neutral detergent to a soft cloth, wring it out tightly, and then wipe the base. Then, wring out the cloth and wipe the base thoroughly to remove any remaining detergent. Wipe the base with a dry, soft cloth to remove any remaining moisture.

• Main Unit

After rinsing hair and dirt, open the shampoo/water inlet and fill with water. Then, turn the unit upside down and drain the water. Repeat this process until no more suds come out.
 When no more suds come out, fill with water and run the unit empty for about 30 seconds. After that, wipe the surface with a dry, soft cloth to remove any remaining moisture.
 Leave the shampoo/water inlet open and dry in a well-ventilated area.

• Brush

Rinse hair and dirt.
 Wipe with a dry, soft cloth to remove any remaining moisture. Leave the unit in a well-ventilated area to dry.

• SUPPORT CENTER INFORMATION

If you would like to inquire or request repairs

Visit <https://www.thanko.jp/view/page/support> and contact us via the support page.
 You can access the support page by scanning the QR code below.

