

TK10A-SS-**+TK10AS-MMB-**
8~12世帯向け

TK10A-SS-**+TK10AS-SMB-**
8~12世帯向け

TK10AS-MMB-**
4~6世帯向け

TK10AS-SSMB-**
6~9世帯向け

TK10AS-SMB-**
4~6世帯向け

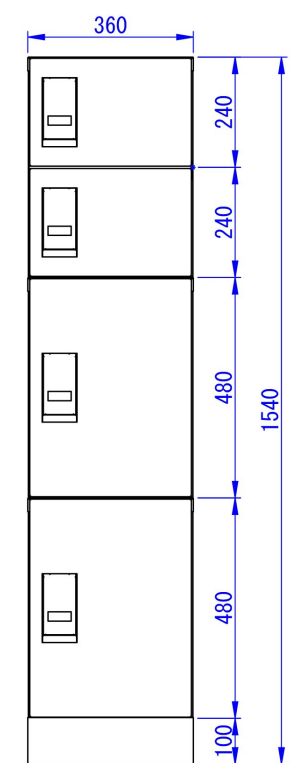
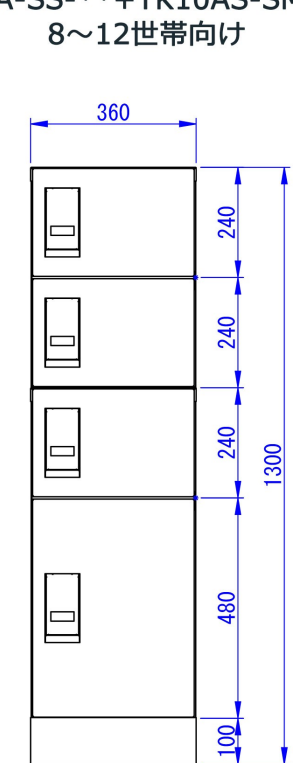
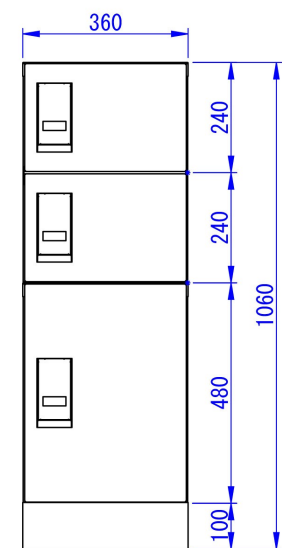
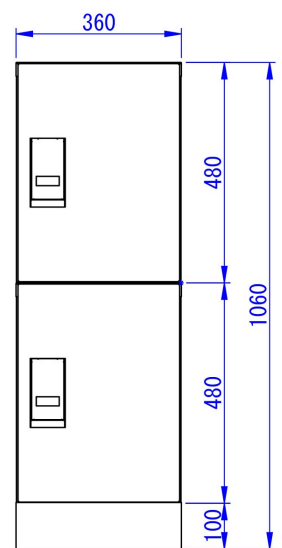
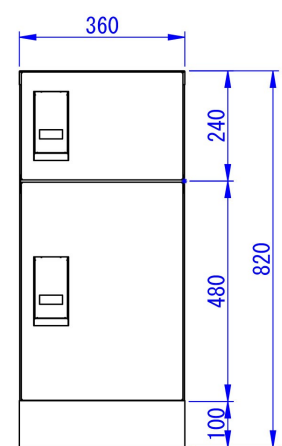

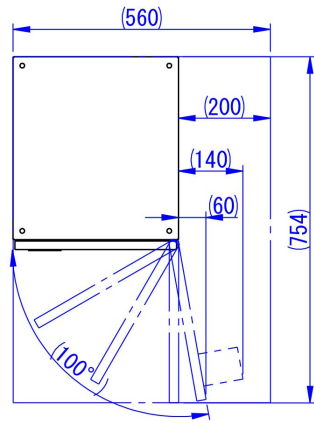

TK10A-4P-**+TK10AS-MMB-**
4世帯向け

TK10A-6P-**+TK10AS-SMB-**
6世帯向け

TK10A-4P-**+TK10AS-SMB-**
4世帯向け

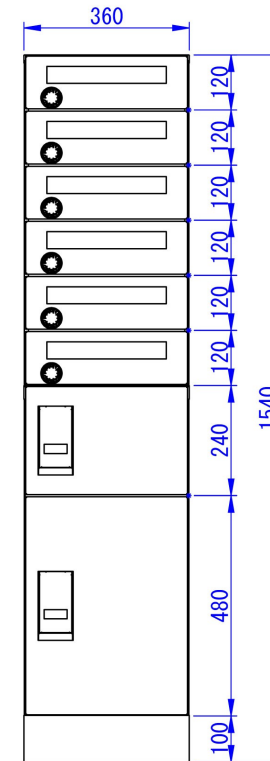
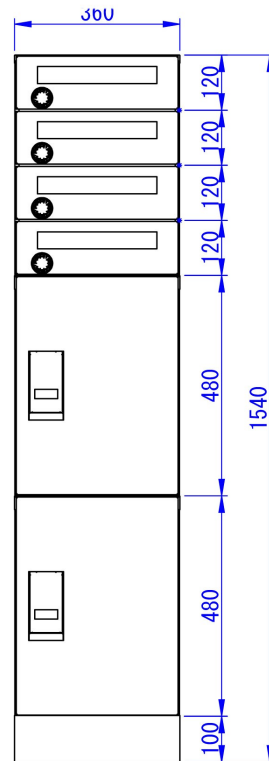
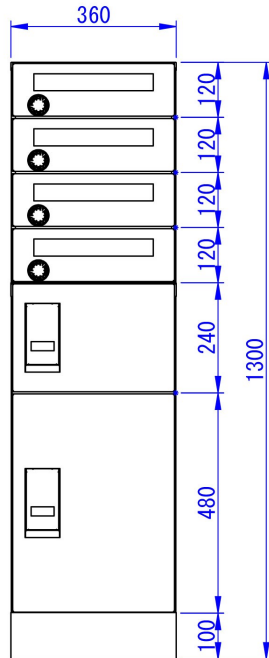

Designed by K_Ikeda	Checked by -	Approved by - date -	Filename SDDV182G0001	Date 24/05/2	Scale 1:12
------------------------	-----------------	-------------------------	--------------------------	-----------------	---------------

少規模マンション・アパート 向け組み合わせ構成例	宅配KEEPER A シンプル	
	ポスト付きセット	Edition - Sheet 1/1

A
B
C
D
E
F