

TITLE	KANTOUCH-THJ
MODEL	THJ9-1/4-BorS

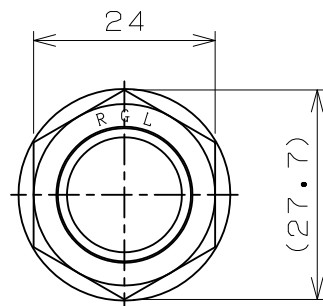
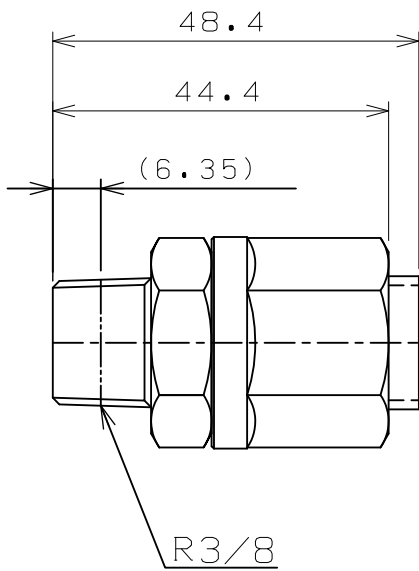

TITLE	KANTOUCH-THJ
MODEL	THJ9-3/8-BorS

THJ9-BorS		RGL JOINT CO., LTD	
DATE	12, 1, 23	A4	1/1