

www.lv8cube.it

**SOLUZIONI DI ARREDO
MODULARE PER OFFICINA**

MODULAR SYSTEM
WORKSHOP FURNITURE



ELEVATE







INDEX

-  **18 MODULI SERVIZI**
SERVICE CABINETS
-    **22 MODULI CASSETTIERE E CARRELLI**
DRAWERS AND SERVICE CABINETS
- 36 PIANE**
WORKTOPS
- 40 COPERTURE PIANI**
WORKTOP COVERINGS
- 42 TAMPONAMENTI**
BACK PANELS
-   **48 MODULI SUPERIORI**
UPPER CABINETS
- 56 STRUTTURE AUTOPORTANTI**
SELF SUPPORTING STRUCTURES
- 58 ARMADI E SCAFFALI**
CLOSET AND SHELF CABINETS
- 66 PARTI SPECIALI**
SPECIAL PARTS
- 68 KIT ILLUMINAZIONE LED**
LED LIGHTING
- 70 COMPONENTI PER IMPIANTISTICA ARIA COMPRESSA ED ELETTRICA**
AIR AND ELECTRIC COMPONENTS

LV8: 50 ANNI DI STORIA



LV8 Elevate nasce dall'esperienza acquisita nel settore automotive. Il marchio LV8®, ideato nel 2002, è oggi Brand Leader nella progettazione, costruzione e fornitura di arredo e attrezzature per concessionarie moto e auto, reti di assistenza, motor sport e industrie.

LV8 Elevate came into being following many years of experience in the automotive industry. Created in 2002, LV8® is now a leader in; innovation, design, manufacture and supply of furniture and equipment for motorcycle and car dealer service networks, motor sports and associated industries.

▶ **1971**

Nasce la Ditta Ferrari Sergio grazie al Sig. Sergio, abile maestro nella lavorazione dei metalli.
A small family company is established by Mr Sergio Ferrari, a skilled and qualified master in metal carpentry.

▶ **1993**

Produzione dei primi prodotti finiti per il settore automotive.
First finished products manufactured for the automotive sector.

▶ **1976**

Produzione delle prime macchine per l'industria alimentare.
First mechanised production for the foodindustry.

▶ **1987**

Ampliamento officina e trasferimento nell' area artigianale di Sorbolo.
Workshop expansion and move to Sorbolo industrial park, near Parma.

▶ **1996**

Acquisto dei primi centri di lavoro ed impianti di saldatura robotizzata.
First CNC machines and welding robots acquired.



LV8: 50 YEARS OF HISTORY

▶ **2000**

Costruzione di un nuovo stabilimento annesso al pre-esistente.
New plant constructed next to the existing site.

▶ **2009**

Nuovo stabilimento di oltre 6000mq coperti a Brescello (Reggio Emilia).
New 6000sqm plant in Brescello (Reggio Emilia).

▶ **2002**

Progettazione e produzione della gamma LV8, cavalletti moto e attrezzature da officina.
Design and manufacturing of LV8 range: motorbike stands and garage equipment.

▶ **2006**

Ampliamento parco macchine e acquisto primi laser.
Machinery implementation and first laser-cutting machines acquired.

▶ **2016**

Creazione e registrazione del marchio Qube®, dedicato alla vasta gamma di arredo tecnico modulare, 100% made in Lv8.

Creation of the Qube® brand, dedicated to a wide range of modular technical furniture, manufactured 100% by Lv8.

▶ **TODAY**

Lv8 Elevate è un oggi un marchio di successo nella produzione di arredo e attrezzature per concessionarie moto e auto, reti di assistenza, motor sport e industrie, trovano nei nostri prodotti la soluzione più adatta alle proprie necessità di ottimizzazione degli spazi, ergonomia, funzionalità ed estetica.

Lv8 Elevate is today a highly successful brand producing furniture and equipment for motorbike and car dealers, service networks, motor sports and allied industries, where our products form the most suitable solution to match their needs; optimizing ergonomics, functionality and aesthetics.



Consulenza tecnica
e progetto personalizzato

Technical consultancy and
customized projects

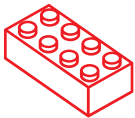

Soluzioni componibili secondo
le diverse esigenze dimensionali
ed estetiche

Modular solutions to match
dimensional and aesthetic needs



Rilievo misure e
questionario tecnico

Measurements
and technical advice



MV Agusta - Taiwan



Finanziamento agevolato (supporto finanziario attraverso noleggio operativo a lungo termine sul 100% del valore di acquisto con rateizzazione da 24 a 60 mesi)

Facilitated financing (financial support through lease purchase on 100% of the purchase value with installment plans from 24 to 60 months) on application, subject to status



Spedizioni in Italia e Worldwide con eventuale installazione presso il Cliente

Deliveries Worldwide with optional installation on site



Customer care, assistenza in fase di pre-vendita e post-vendita

Dedicated customer care during both pre- and after-sales



MV Agusta - Taiwan

L'EVOLUZIONE DEL MODULO, L'ARREDO DI NUOVA GENERAZIONE

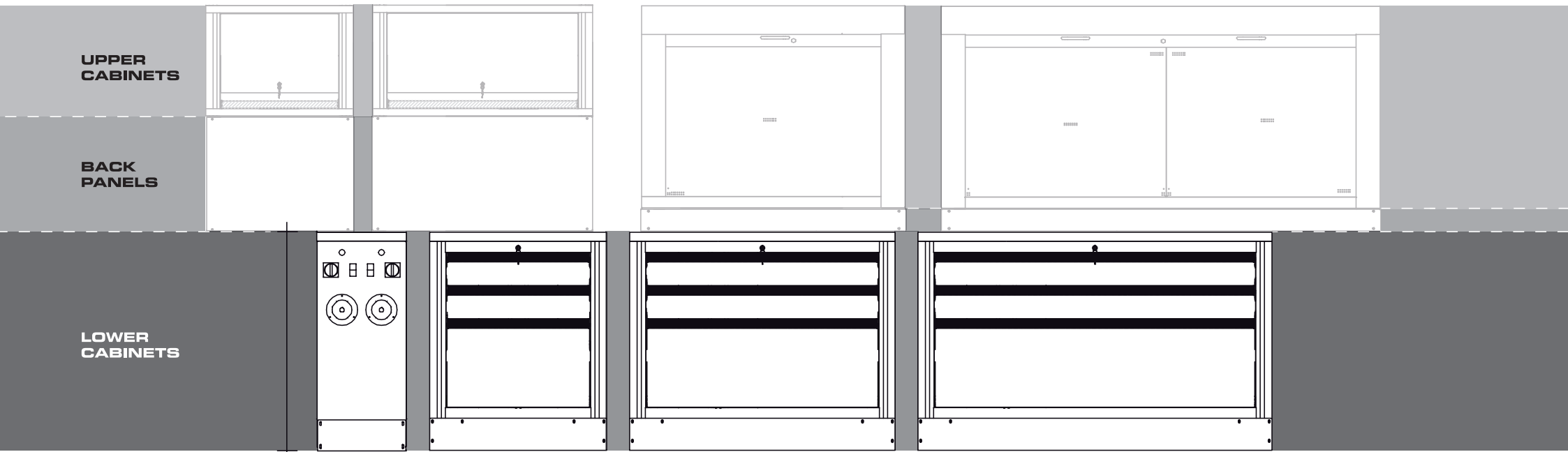

400 mm

800 mm

1200 mm

1600 mm



MODULE EVOLUTION, THE NEW GENERATION FURNITURE

p_53

800 mm

1200 mm

p_49

1200 mm

2000 mm

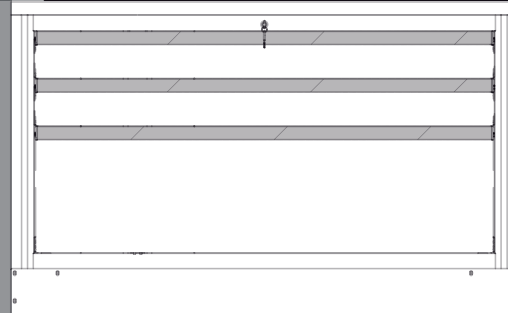
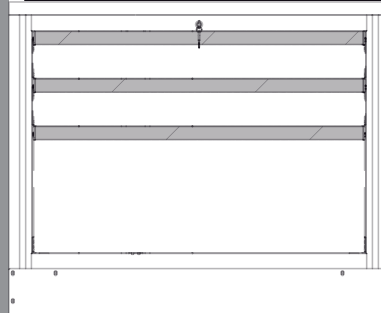
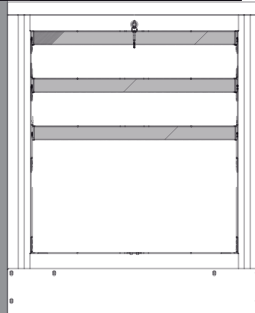
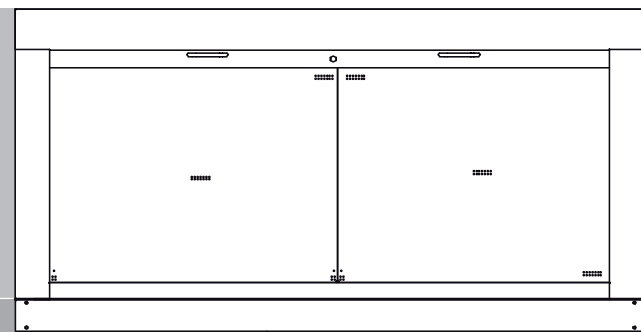
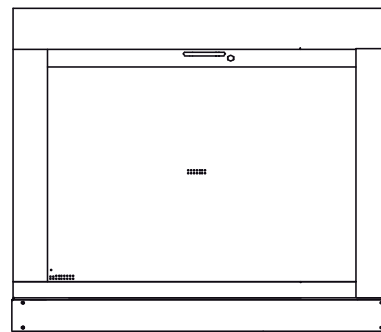
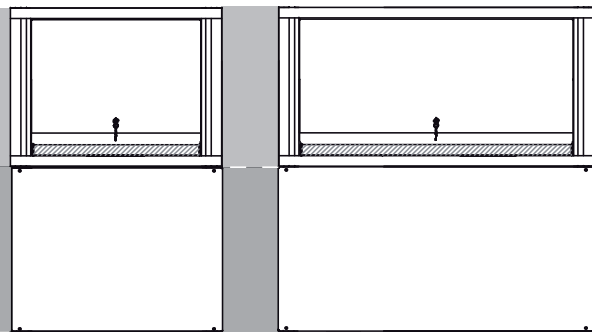

L'EVOLUZIONE DEL MODULO, L'ARREDO DI NUOVA GENERAZIONE



+ CONTENIMENTO + CONTAINMENT

L'arredo Qube® vanta soluzioni modulari basate su multipli di 400 mm, con profondità e larghezze maggiorate rispetto allo standard. Aprire un cassetto Qube significa godere del 30% di volume e 20% di piano di lavoro in più!

Qube® modular furniture solutions are based on multiples of 400 mm, deeper and wider than standard sizes. Opening a Qube drawers give you more than 30% increase in volume and 20% on worktops!



+ CAPACITÀ + CAPACITY

Cassetti da 75 kg sino a 300 kg di portata, ad estrazione totale.

Drawers from 75 kg up to 300 kg capacity, fully open.

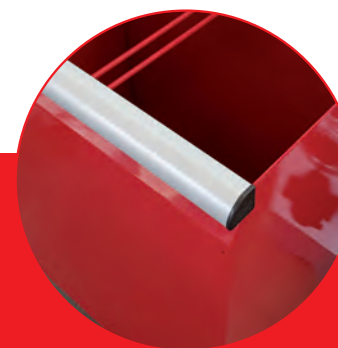
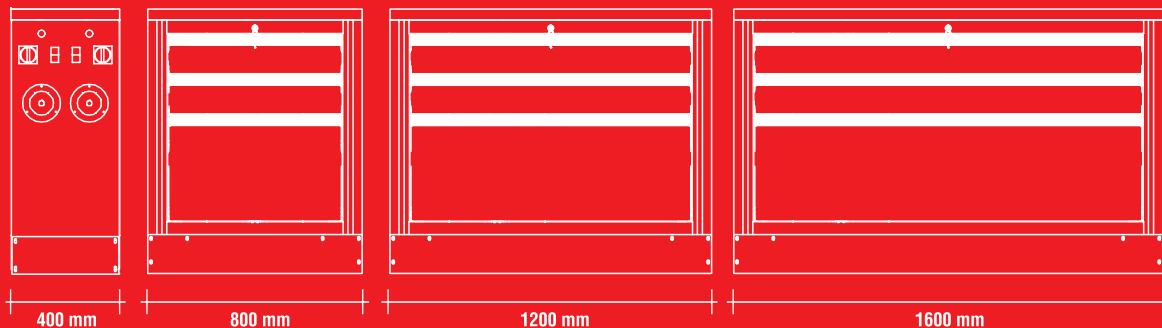

Qube® riporta la maniglia come elemento protagonista del design dell'officina, in alluminio estruso spazzolato e anodizzato.

Qube® brings back the handle as main element of the workshop design in anodized extruded brushed aluminum.



Guide telescopiche con gabbia a sfere ad alta capacità di carico e fermo di sicurezza per elevate prestazioni.

Telescopic slides with bearings cage with high-load capacity and safety lock for high performances.

MODULE EVOLUTION - NEW GENERATION FURNITURE

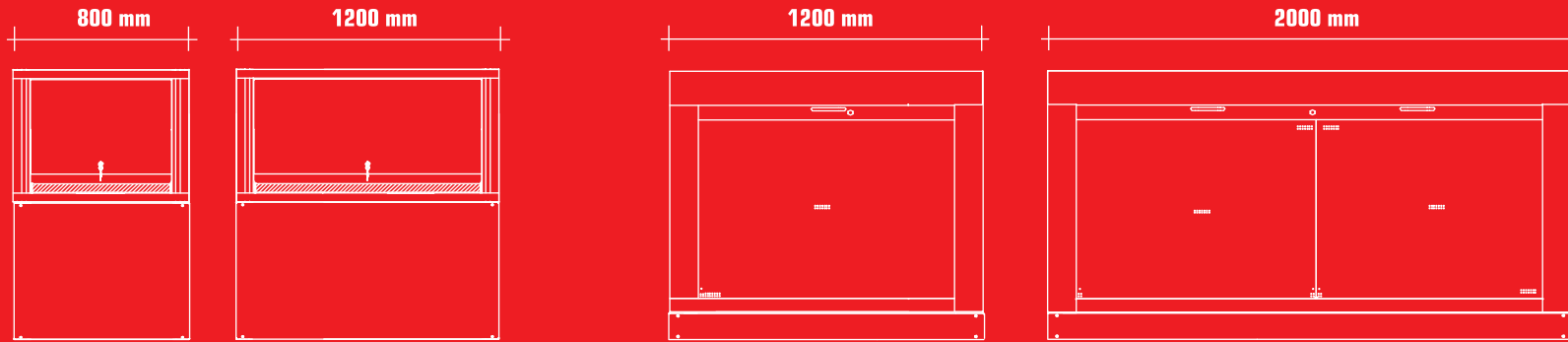

+ ORGANIZZAZIONE + ORGANIZATION

La vasta scelta di elementi componibili Qube® garantisce una maggiore distribuzione delle zone di contenimento.

The wide choice of Qube® modular components provides greater variety for storage areas.



+ CONVENIENZA + CONVENIENCE

Soluzioni senza piedi e moduli multiservizio "compatti" per una ottimizzazione dello spazio e risparmio di denaro.

Solutions without feet and 'compact' multiservice modules for space optimization and cost savings.



+ SOLUZIONI + SOLUTIONS

La perfetta simmetria tra moduli alti e moduli bassi consente di sviluppare infinite soluzioni di configurazione.

Perfect symmetry between high and low level modules allows you to create a multitude of configurations.

MODULE EVOLUTION, THE NEW GENERATION FURNITURE

La caratteristica peculiare di un arredo componibile è la sua versatilità, con la possibilità di sviluppare differenti tipi di composizione in una stessa metratura.

**QUESTE SONO SOLO
ALCUNE DELLE INFINITE
SOLUZIONI QUBE®
PER ALLESTIRE
UNA PARETE DI 2 METRI!**

The particular characteristics of modular furniture is its versatility with the possibility to create many different configurations in the same space.

**THESE ARE ONLY
FEW POSSIBLE SOLUTIONS
OF QUBE® WITHIN
2 METERS!**

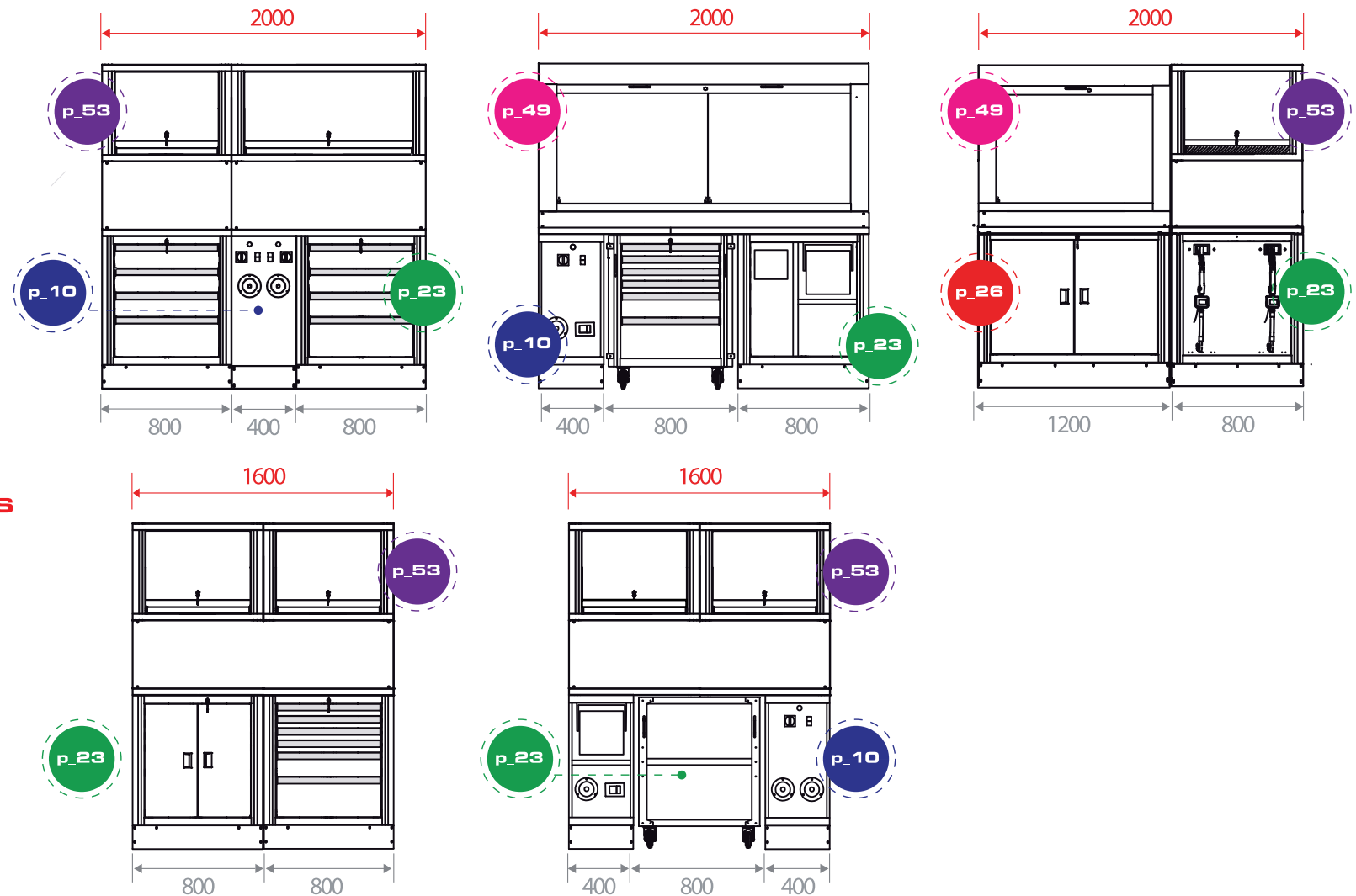



LE INFINITE SOLUZIONI QUBE®

MODULI 400mm

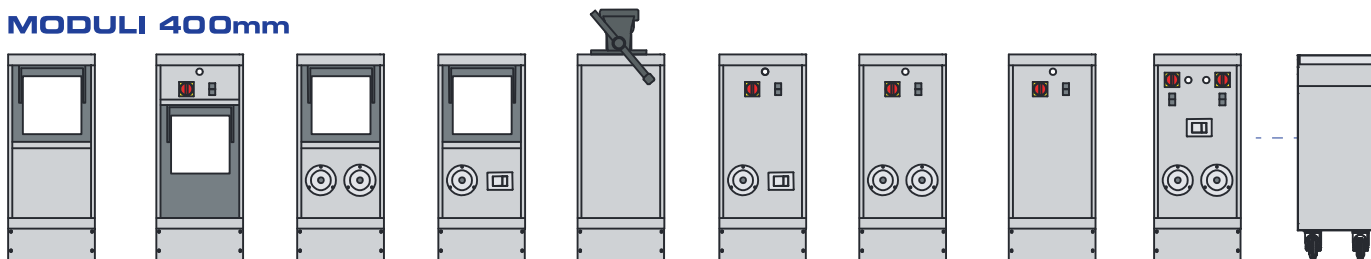

MODULI 800mm

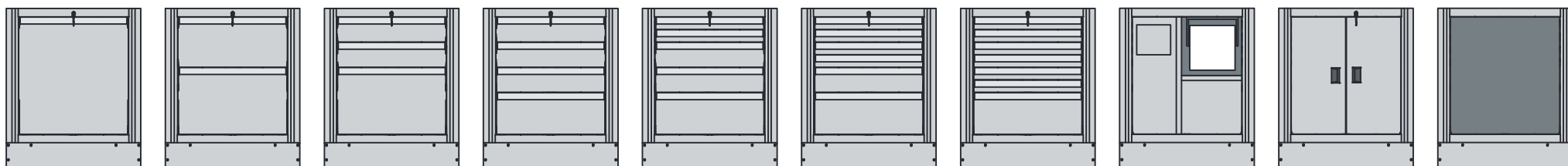

MODULI 1200mm

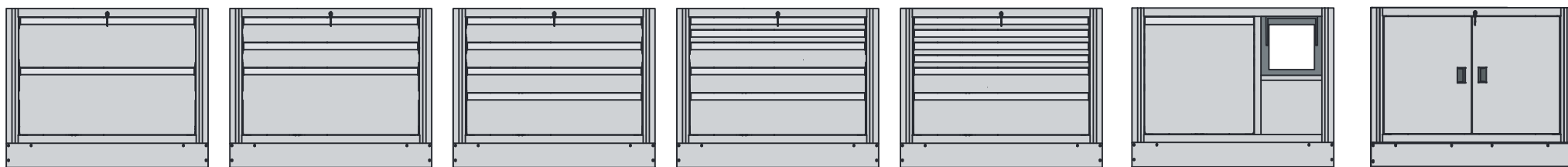

MODULI 1600mm

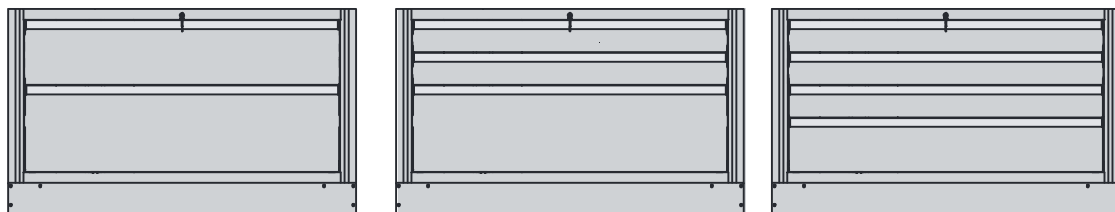

THE QUBE® INFINITELY MANY SOLUTIONS

p_10

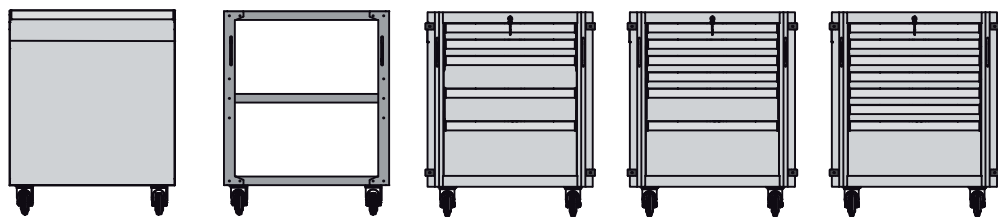

p_23

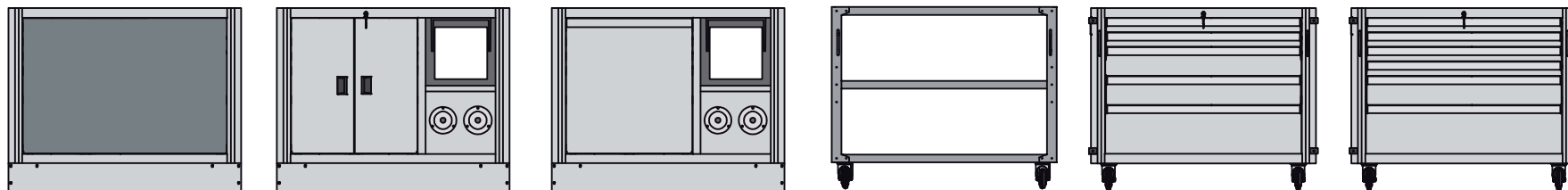

p_26

p_29

THE SYNTHESIS OF OUR MULTIPLICITY

MODULI ALTI

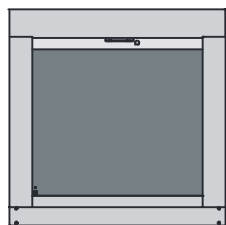
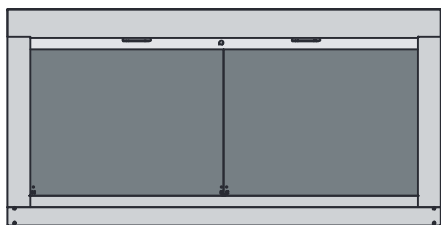

p_49

MODULI ALTI

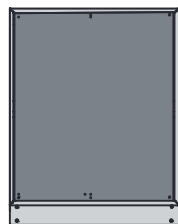
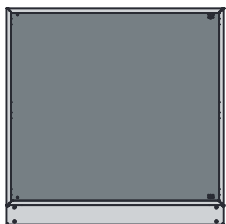
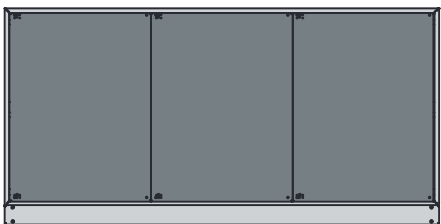

p_51

MODULI ALTI

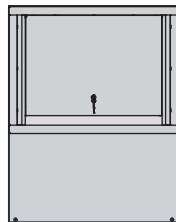
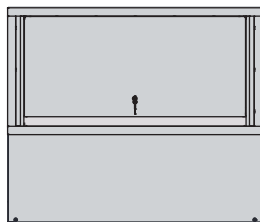
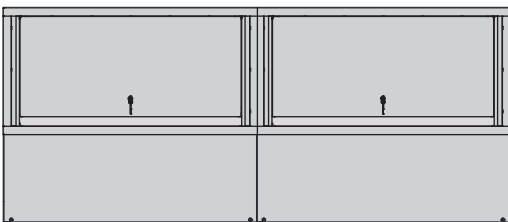

p_53

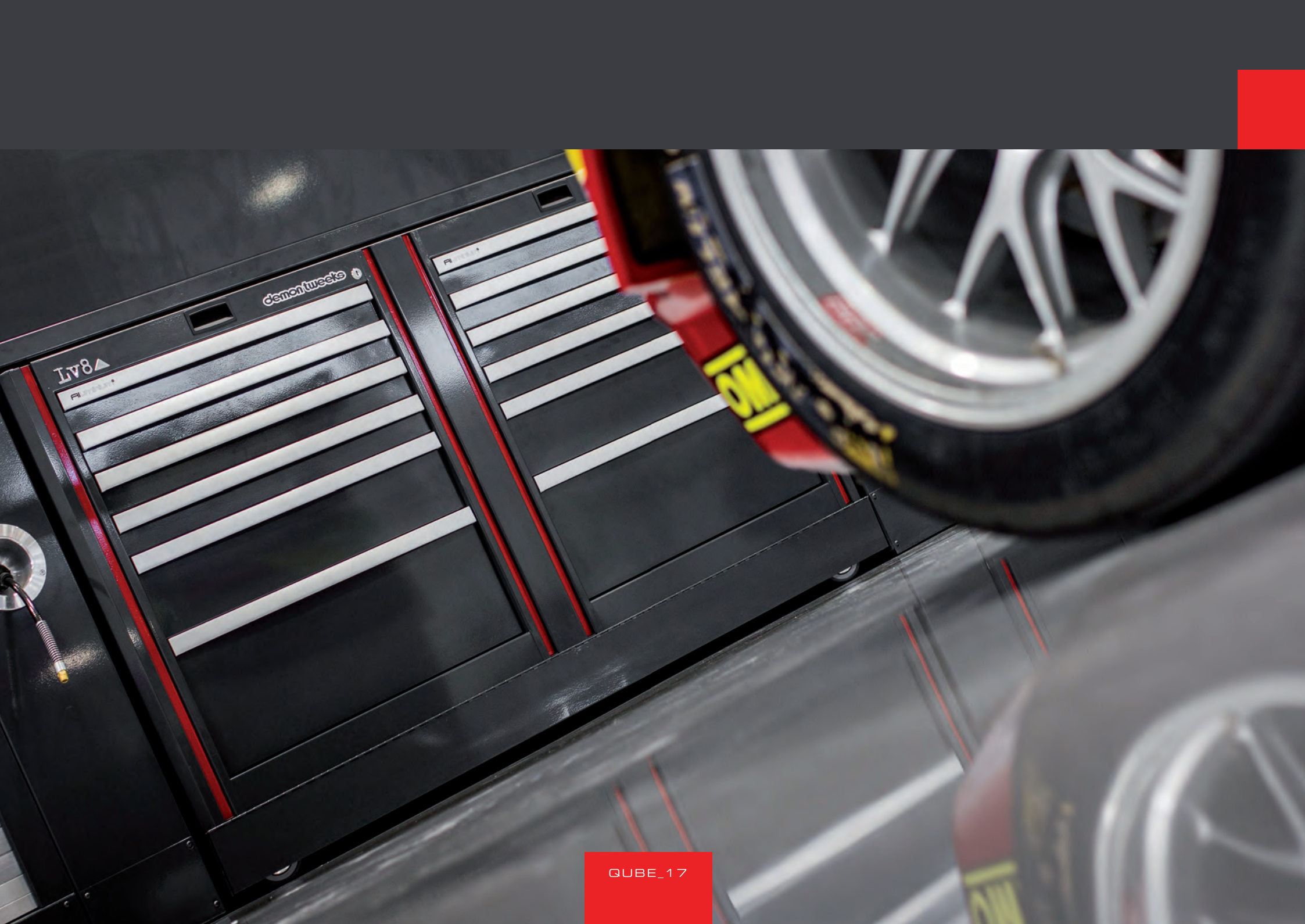

Lv8▲

demon tweaks

A

MODULO SERVIZI

SERVICE CABINETS

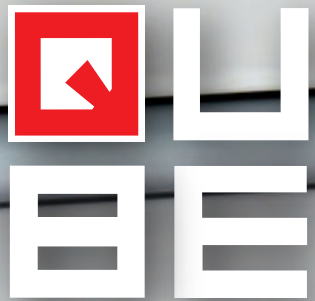

100%
made in
ITALY



100%
made in
Lv8

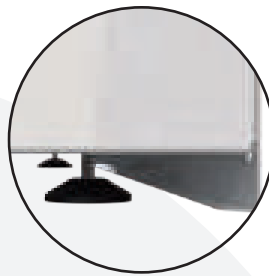
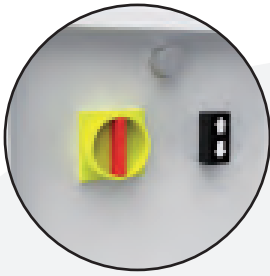

400 mm

- OPTION**
- SERVICES
 - AIR
 - ELECTRICITY
 - OIL
 - CONTROLS
 - BENCH VICE
 - STORAGE
 - WASTE BIN

**STRUTTURA
DI LAMIERA LAMIERA
ELETTOZINCATA 1,5 MM
VERNICIATA A
POLVERE EPOSSIDICA**
*ELECTRO-GALVANIZED
SHEET METAL
STRUCTURE 1.5 MM
EPOXY POWDER COATED*



**BASI INTEGRATE
CON PIEDINI
REGOLABILI IN ALTEZZA**
*INTEGRATED BASES
WITH HEIGHT ADJUSTABLE FEET*

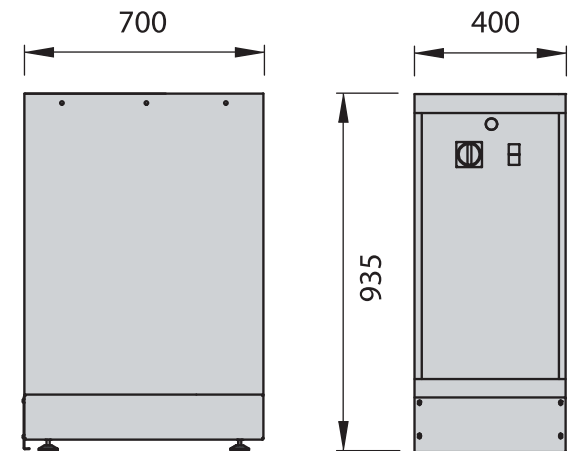

QUBE_19

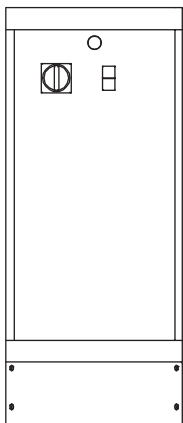

EQMS4.1K30

Modulo L400 con predisposizione per 1 centralina elettroidraulica (sollevatore auto K30)
Cabinet L400 with predisposition for 1 electro-hydraulic unit (K30 car lift)

EQMS4.1K36

Modulo L400 con predisposizione per 1 centralina elettroidraulica (sollevatore auto K36)
Cabinet L400 with predisposition for 1 electro-hydraulic unit (K36 car lift)

EQMS4.1N

Modulo L400 con predisposizione per 1 centralina elettroidraulica (sollevatore moto Nano)
Cabinet L400 with predisposition for 1 electro-hydraulic unit (Nano motorcycle lift)

EQMS4.1K31

Modulo 400 con predisposizione per centralina idraulica sollevatore auto K31
Cabinet L400 with predisposition for hydraulic unit K31 car lift.

EQMS4.1G

Modulo L400 con predisposizione per 1 kit comandi (sollevatore moto Goldrake)
Cabinet L400 with predisposition for 1 controls kit (Goldrake motorcycle lift)

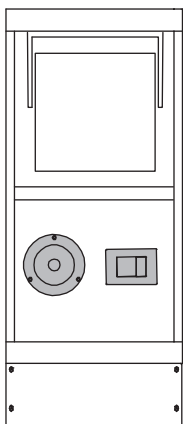

EQMS4.EAPR

Modulo L400 con predisposizione per 1 arrotolatore, 1 presa e vano portarotolo
Cabinet L400 with predisposition for 1 hose reel, 1 socket and paper holder compartment

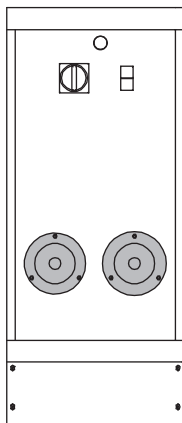

EQMS4.1N2A

Modulo L400 con predisposizione per 2 arrotolatori e 1 centralina elettroidraulica (sollevatore moto Nano)
Cabinet L400 with predisposition for 2 hose reels and 1 electro-hydraulic unit (Nano motorcycle lift)

EQMS4.1G2A

Modulo L400 con predisposizione per 2 arrotolatori e 1 kit comandi (sollevatore moto Goldrake)
Cabinet L400 with predisposition for 2 hose reels and 1 control kit (Goldrake motorcycle lift)

EQMS4.2G2A

Modulo L400 con predisposizione per 2 arrotolatori e 2 kit comandi (sollevatore moto Goldrake)
Cabinet L400 with predisposition for 2 hose reels and 2 controls kits (Goldrake motorcycle lift)

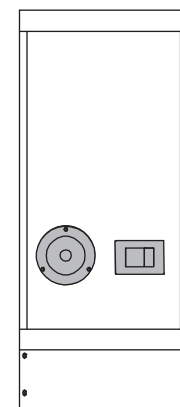

EQMS4.EA

Modulo L400 con predisposizione per 1 arrotolatore e 1 presa
Cabinet L400 with predisposition for 1 hose reel and 1 socket

EQMS4.2E2A

Modulo L400 con predisposizione per 2 arrotolatori e 2 prese
Cabinet L400 with predisposition for 2 hose reels and 2 sockets

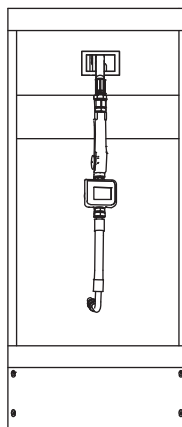

EQMS4.10

Modulo L400 con 1 arrotolatore olio e 1 pistola contalitri digitale
Cabinet L400 with predisposition for 1 oil hose reel and 1 metred oil gun

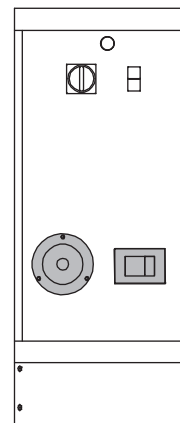

EQMS4.1NEA

Modulo L400 con predisposizione per 1 arrotolatore, 1 presa e 1 centralina elettroidraulica (sollevatore moto Nano)
Cabinet L400 with predisposition for 1 hose reel, 1 socket and 1 electro-hydraulic unit (Nano motorcycle lift)

EQMS4.1GEA

Modulo L400 con predisposizione per 1 arrotolatore, 1 presa e 1 kit comandi (sollevatore moto Goldrake)
Cabinet L400 with predisposition for 1 hose reel, 1 socket and 1 control kit (Goldrake motorcycle lift)

EQMS4.2GEA

Modulo L400 con predisposizione per 1 arrotolatore, 1 presa e 2 kit comandi (sollevatore moto Goldrake)
Cabinet L400 with predisposition for 1 hose reel, 1 socket and 2 control kits (Goldrake motorcycle lift)

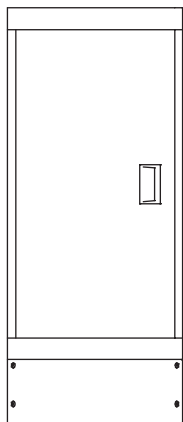

EQMS4.1A

Modulo L400 con 1 antina e 1 ripiano
Cabinet L400 with 1 door and 1 shelf

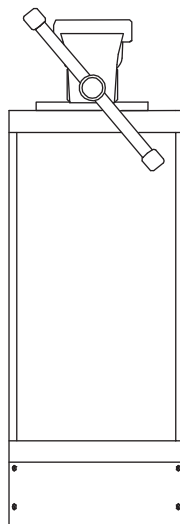

EQMS4.MM

Modulo 400 con antina e supporto
per morsa a scomparsa (morsa esclusa)
Cabinet 400 with door and folding
support for bench vice (vice not included)

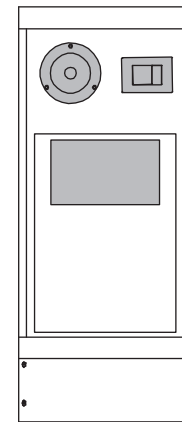

EQMS4.EAS1

Modulo L400 con predisposizione
per 1 arrotolatore, 1 presa e gettacarta
Cabinet L400 with predisposition for 1 hose reel,
1 socket and integrated waste paper bin

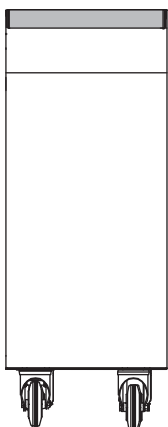

EQMSK.3605

Carrello spazzatura L360 P500
Rubbish collection trolley L360 D500



MODULI CASSETTIERE E CARRELLI

DRAWERS, SERVICE AND TROLLEY CABINETS

LV8 ▲



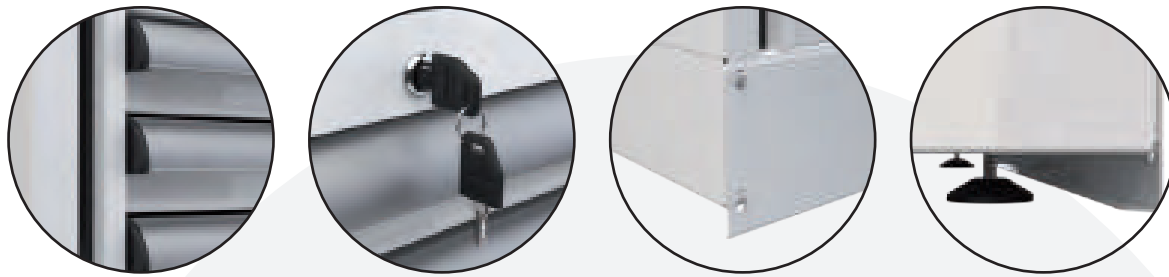

**STRUTTURA DI LAMIERA
ELETTOZINCATA 1,5 MM
VERNICIATA A
POLVERE EPOSSIDICA**
*ELECTRO-GALVANIZED
SHEET METAL
STRUCTURE 1.5 MM
EPOXY POWDER COATED*

**GUIDE
AD ALTA PORTATA
HIGH CAPACITY
SLIDES**

**BASI INTEGRATE
CON PIEDINI
REGOLABILI IN ALTEZZA**
*INTEGRATED BASES
WITH HEIGHT ADJUSTABLE FEET*

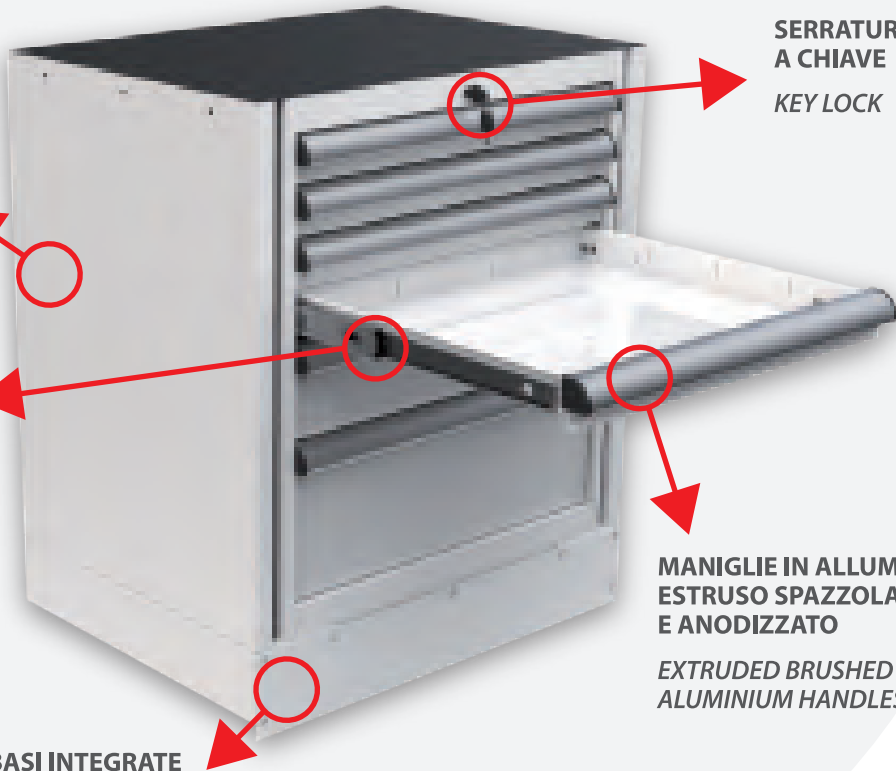

**SERRATURE
A CHIAVE
KEY LOCK**

**MANIGLIE IN ALLUMINIO
ESTRUSO SPAZZOLATO
E ANODIZZATO**
*EXTRUDED BRUSHED
ALUMINIUM HANDLES*

MODULE 800

mm 800

H DRAWER 75 mm		W 615 mm D 540 mm KG 100
H DRAWER 150 mm		W 615 mm D 540 mm KG 100
H DRAWER 250 mm		W 615 mm D 540 mm KG 100
H DRAWER 300 mm		W 615 mm D 540 mm KG 100
H DRAWER 400 mm		W 615 mm D 540 mm KG 200

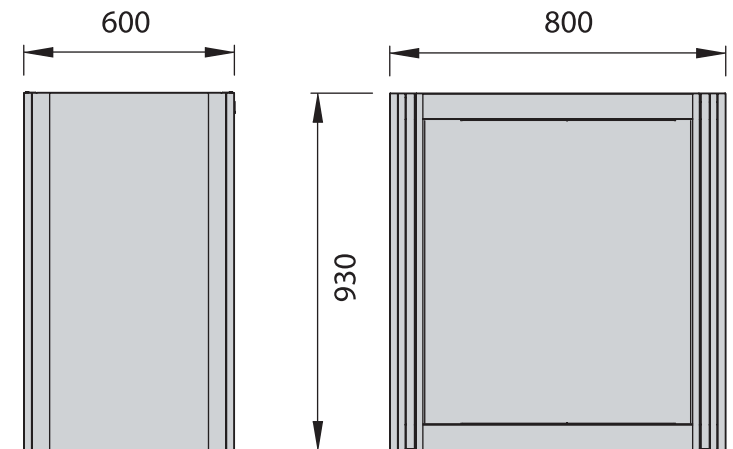

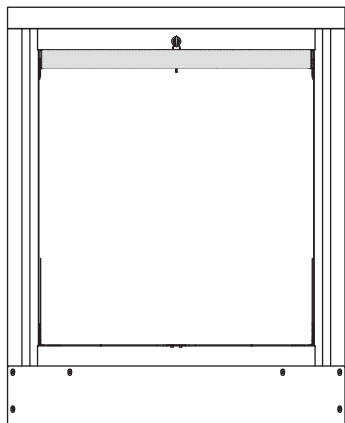

700 mm	100 kg
--------	--------

EQM1C.0806

Modulo L800 con 1 cassetto per spazzatura, completo di 2 cestini zincati

Cabinet L800 with 1 rubbish collection drawer, complete with 2 galvanised baskets

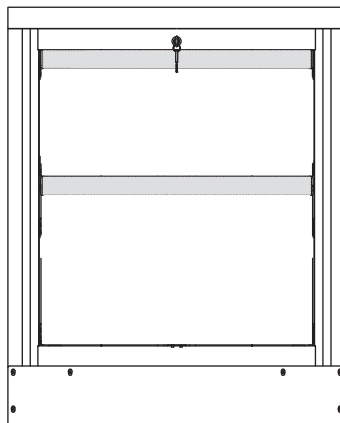

300 mm	100 kg
400 mm	200 kg

EQM2C.0806

Modulo L800 con 2 cassetti

Cabinet L800 with 2 drawers

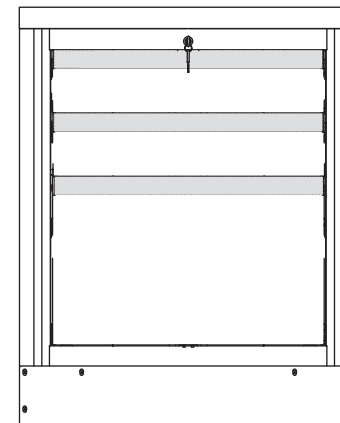

150 mm	100 kg
150 mm	100 kg
400 mm	200 kg

EQM3C.0806

Modulo L800 con 3 cassetti

Cabinet L800 with 3 drawers

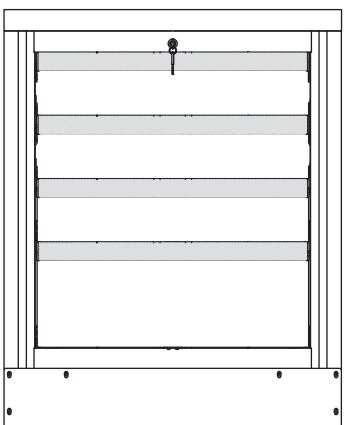

150 mm	100 kg
150 mm	100 kg
150 mm	100 kg
250 mm	100 kg

EQM4C.0806

Modulo L800 con 4 cassetti

Cabinet L800 with 4 drawers

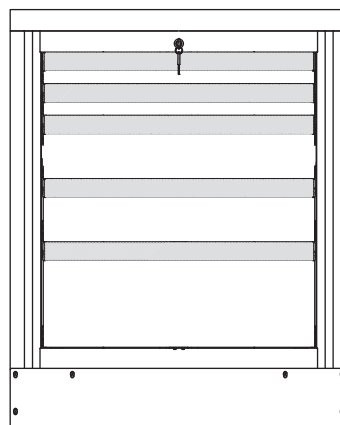

75 mm	100 kg
75 mm	100 kg
150 mm	100 kg
150 mm	100 kg
250 mm	100 kg

EQMSC.0806

Modulo L800 con 5 cassetti

Cabinet L800 with 5 drawers

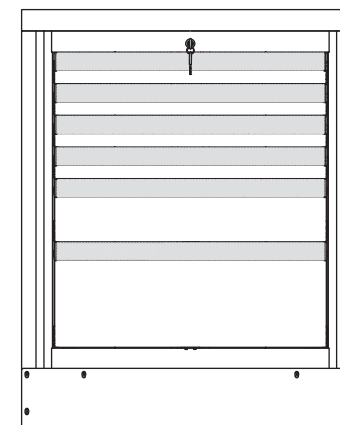

75 mm	100 kg
75 mm	100 kg
75 mm	100 kg
75 mm	100 kg
150 mm	100 kg
250 mm	100 kg

EQM6C.0806

Modulo L800 con 6 cassetti

Cabinet L800 with 6 drawers

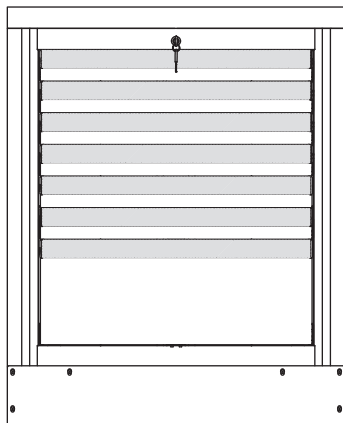

75 mm	100 kg
75 mm	100 kg
75 mm	100 kg
75 mm	100 kg
75 mm	100 kg
75 mm	100 kg
250 mm	100 kg

EQM7C.0806

Modulo L800 con 7 cassetti
Cabinet L800 with 7 drawers

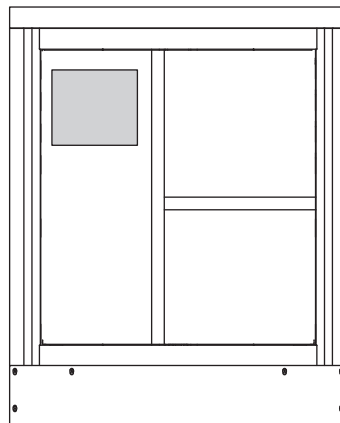

EQMS1.0806

Modulo Servizi L800 con cestino,
portarotolo e antina
Service Module L800 with rubbish bin, paper
holder compartment and door

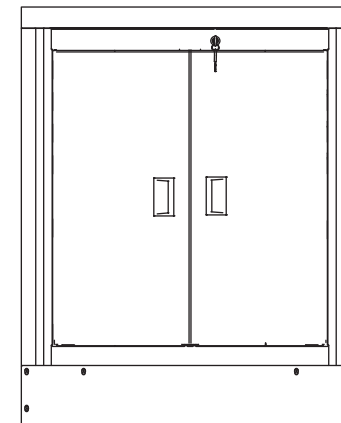

EQM2A.0806

Modulo L800 con 2 ante con chiusura a chiave e
ripiano regolabile
Module L800 with 2 doors with key lock and
adjustable shelf

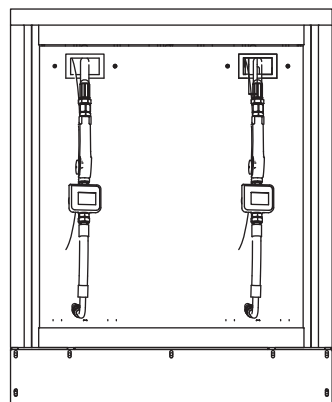

EQM30.0806

Modulo Distribuzione olio L800 con 3
arrotolatori e 3 pistole contalitri digitali
Oil Distribution module L800 with 3 hose
reels and 3 metred oil guns

EQM10.0806

Modulo Distribuzione olio L800 con 1
arrotolatore e 1 pistola contalitri digitali
Oil Distribution module L800 with 1 hose
reels and 1 metred oil gun

EQM20.0806

Modulo Distribuzione olio L800 con 2
arrotolatori e 2 pistole contalitri digitali
Oil Distribution module L800 with 2 hose
reels and 2 metred oil guns

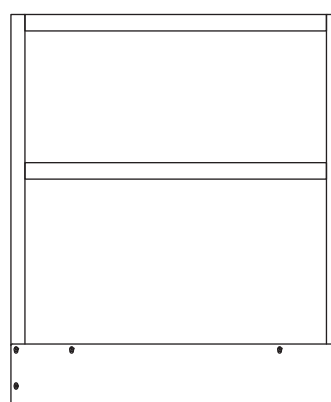

EQMRO.0806

Modulo L800 con ripiano a giorno
Module L800 with open shelf

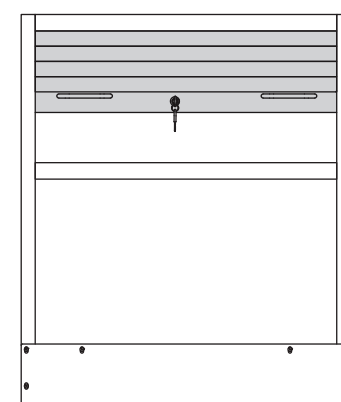

EQMRT.0806

Modulo L800 con tapparella avvolgibile e ripiano a giorno
Module L800 with roller shutter and open shelf

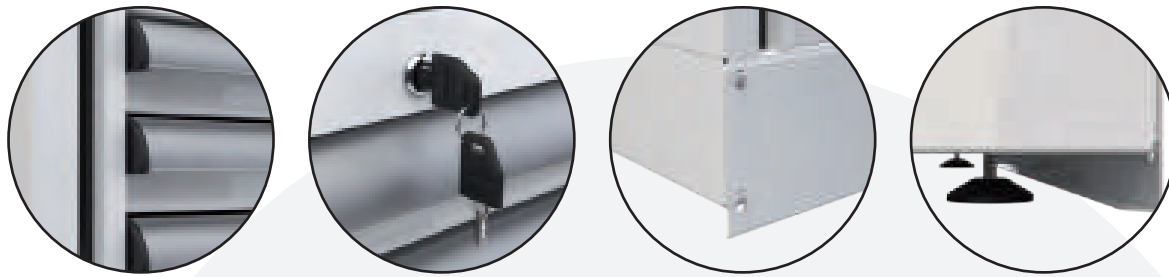

**STRUTTURA DI LAMIERA
ELETTROZINCATA 1,5 MM
VERNICIATA A
POLVERE EPOSSIDICA**

**ELECTRO-GALVANIZED
SHEET METAL
STRUCTURE 1.5 MM
EPOXY POWDER COATED**

**GUIDE
AD ALTA PORTATA
HIGH CAPACITY
SLIDES**

**BASI INTEGRATE
CON PIEDINI
REGOLABILI IN ALTEZZA
INTEGRATED BASES
WITH HEIGHT ADJUSTABLE FEET**

**SERRATURE
A CHIAVE
KEY LOCK**

**MANIGLIE IN ALLUMINIO
ESTRUSO SPAZZOLATO
E ANODIZZATO
EXTRUDED BRUSHED
ALUMINIUM HANDLES**

MODULE 1200

mm 1200

**1200
mm**

**H
DRAWER**
75 mm



**W 1015 mm
D 540 mm
KG 100**

**H
DRAWER**
150 mm



**W 1015 mm
D 540 mm
KG 150**

**H
DRAWER**
250 mm



**W 1015 mm
D 540 mm
KG 150**

**H
DRAWER**
300 mm



**W 1015 mm
D 540 mm
KG 150**

**H
DRAWER**
400 mm



**W 1015 mm
D 540 mm
KG 300**

600

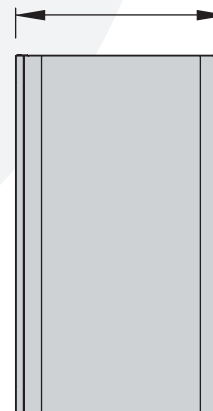

1200

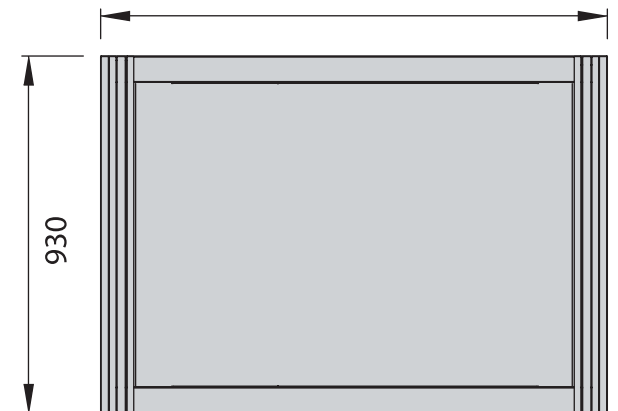

930

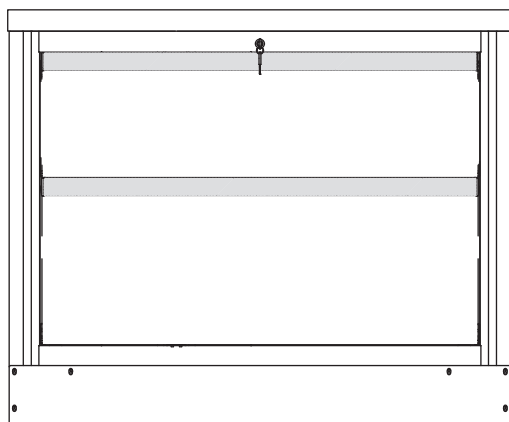

EQM2C.1206

Modulo L1200 con 2 cassetti
Cabinet L1200 with 2 drawers



1x300 mm	150 kg
1x400 mm	300 kg

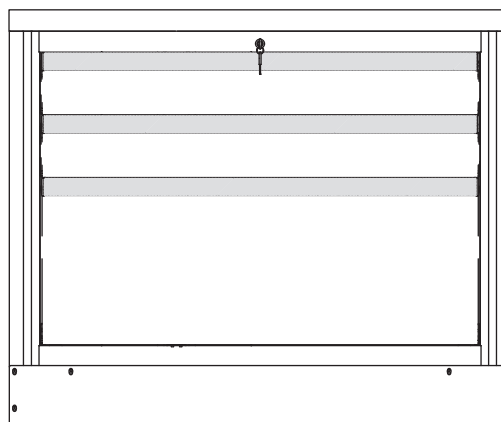

EQM3C.1206

Modulo L1200 con 3 cassetti
Cabinet L1200 with 3 drawers



2x150 mm	150 kg
1x400 mm	300 kg

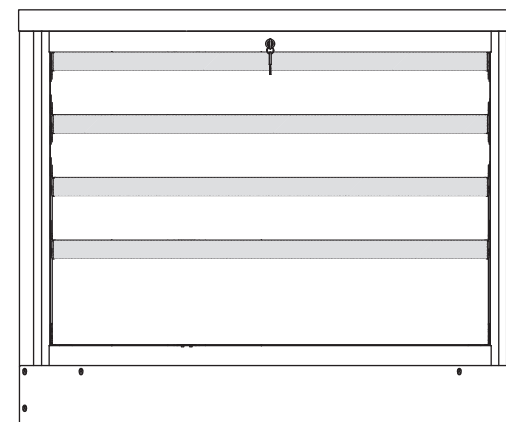

EQM4C.1206

Modulo L1200 con 4 cassetti
Cabinet L1200 with 4 drawers



3x150 mm	150 kg
1x250 mm	150 kg

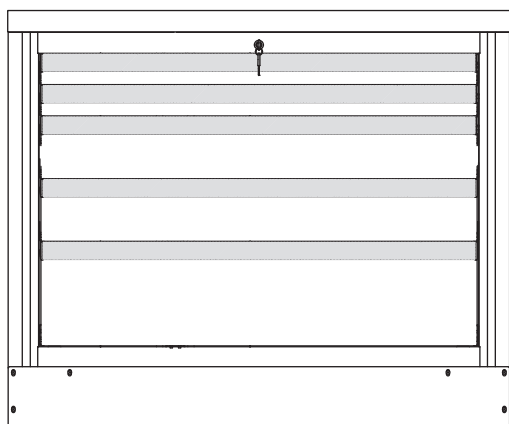

EQM5C.1206

Modulo L1200 con 5 cassetti
Cabinet L1200 with 5 drawers



2x75 mm	180 kg
2x150 mm	150 kg
1x250 mm	150 kg

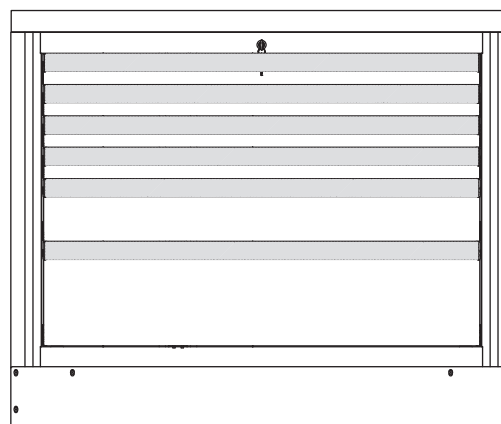

EQM6C.1206

Modulo L1200 con 6 cassetti
Cabinet L1200 with 6 drawers



4x75 mm	180 kg
1x150 mm	180 kg
1x250 mm	150 kg

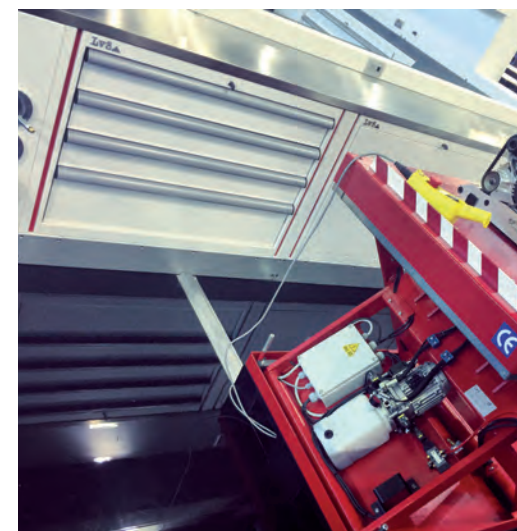

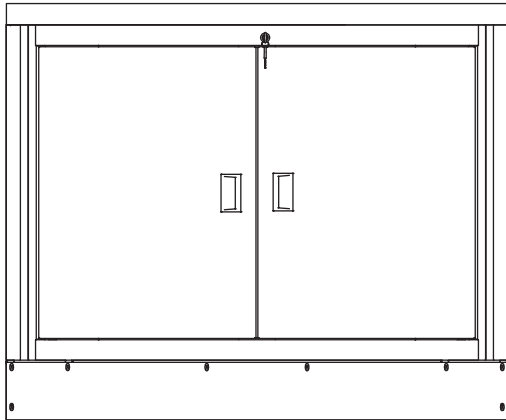

EQM2A.1206

Modulo L1200 con 2 ante con chiusura a chiave e ripiano regolabile

Cabinet L1200 with 2 doors with key lock and adjustable shelf

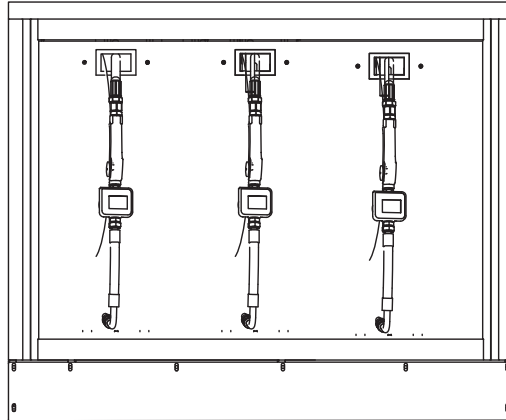

EQM30.1206

Modulo Distribuzione olio L1200 con 3 arrotolatori e 3 pistole contalitri digitali

Oil Distribution cabinet L1200 with 3 hose reels and 3 metred oil guns

EQM10.1206

Modulo Distribuzione olio L1200 con 1 arrotolatore e 1 pistola contalitri digitali

Oil Distribution cabinet L1200 with 1 hose reel and 1 metred oil gun

EQM40.1206

Modulo Distribuzione olio L1200 con 4 arrotolatori e 4 pistole contalitri digitali

Oil Distribution cabinet L1200 with 4 hose reels and 4 metred oil guns

EQM20.1206

Modulo Distribuzione olio L1200 con 2 arrotolatori e 2 pistole contalitri digitali

Oil Distribution cabinet L1200 with 2 hose reels and 2 metred oil guns

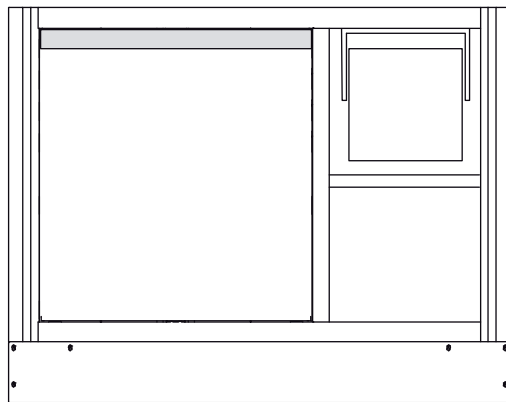

EQMS1.1206

Modulo Servizi L1200 con cassetto per spazzatura differenziata a 2 scomparti , antina e portarotolo

Service cabinet L1200 with drawer for waste separation with 2 compartments , door and paper holder compartment

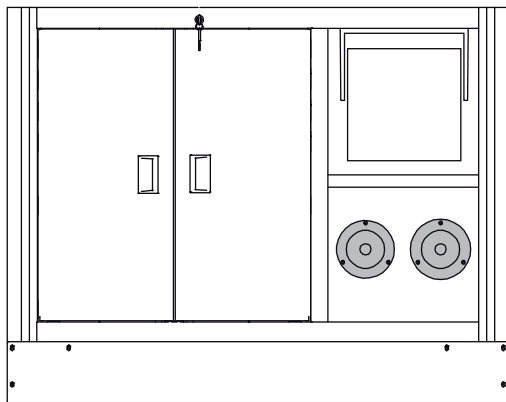

EQMSA.1206

Modulo Servizi L1200 con 2 ante con chiusura a chiave , 2 arrotolatori e portarotolo

Service cabinet L1200 with 2 doors with key lock, 2 hose reels and paper holder compartment

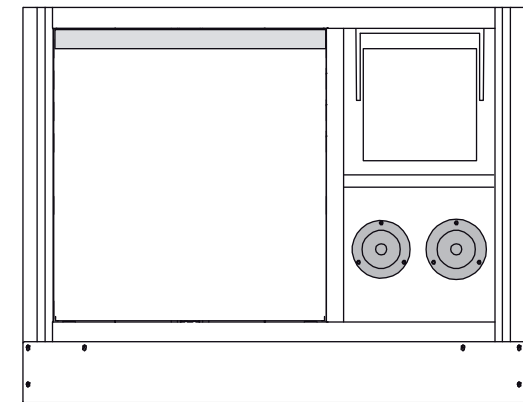

EQMS2.1206

Modulo Servizi L1200 con cassetto per spazzatura differenziata a 2 scomparti , 2 arrotolatori e portarotolo

Service cabinet L1200 with drawer for waste separation with 2 compartments, 2 hose reels and paper holder compartment

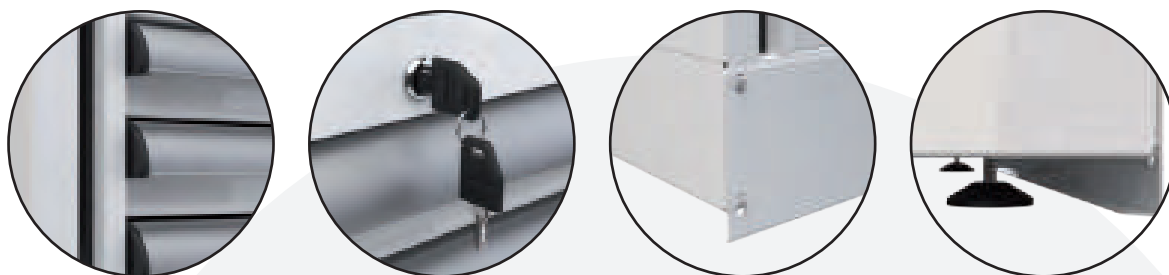

STRUTTURA DI LAMIERA ELETTOZINCATA 1,5 MM VERNICIATA A POLVERE EPOSSIDICA
ELECTRO-GALVANIZED SHEET METAL STRUCTURE 1.5 MM EPOXY POWDER COATED

GUIDE AD ALTA PORTATA
HIGH CAPACITY SLIDES

BASI INTEGRATE CON PIEDINI REGOLABILI IN ALTEZZA
INTEGRATED BASES WITH HEIGHT ADJUSTABLE FEET

MANIGLIE IN ALLUMINIO ESTRUSO SPAZZOLATO E ANODIZZATO
EXTRUDED BRUSHED ALUMINIUM HANDLES

SERRATURE A CHIAVE
KEY LOCK

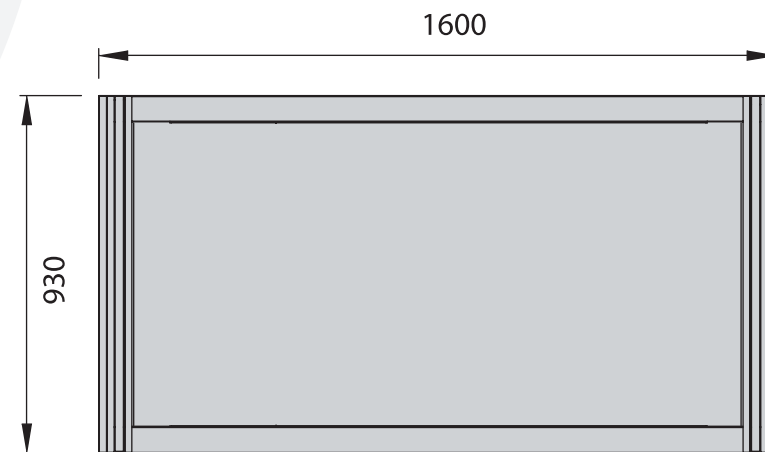
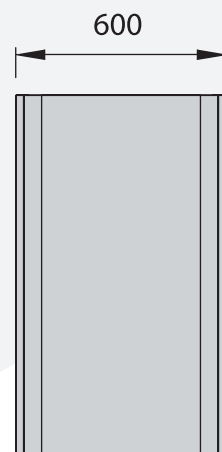

MODULE 1600

mm 1600



H DRAWER 150 mm	M 	W 1415 mm D 540 mm KG 150
H DRAWER 250 mm	L 	W 1415 mm D 540 mm KG 150
H DRAWER 300 mm	XL 	W 1415 mm D 540 mm KG 150
H DRAWER 400 mm	XXL 	W 1415 mm D 540 mm KG 300

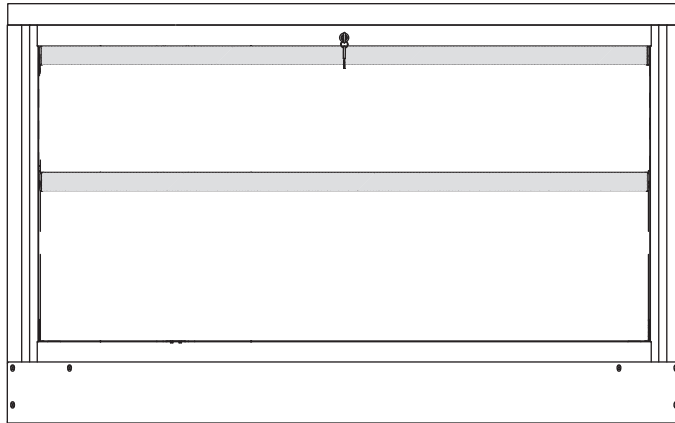

EQM2C.1606

Modulo L1600 con 2 cassetti
Cabinet L1600 with 2 drawers



1x300 mm	150 kg
1x400 mm	300 kg

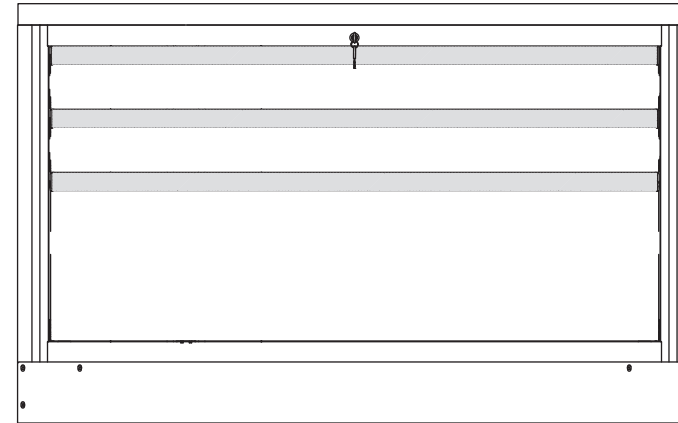

EQM3C.1606

Modulo L1600 con 3 cassetti
Cabinet L1600 with 3 drawers



2x150 mm	150 kg
1x400 mm	300 kg

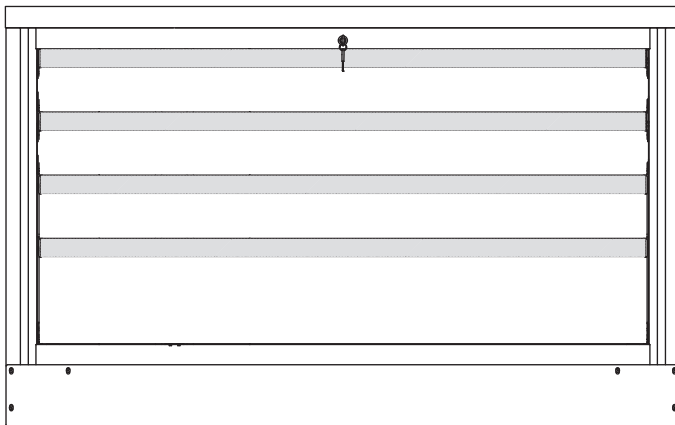

EQM4C.1606

Modulo L1600 con 4 cassetti
Cabinet L1600 with 4 drawers



3x150 mm	150 kg
1x250 mm	150 kg

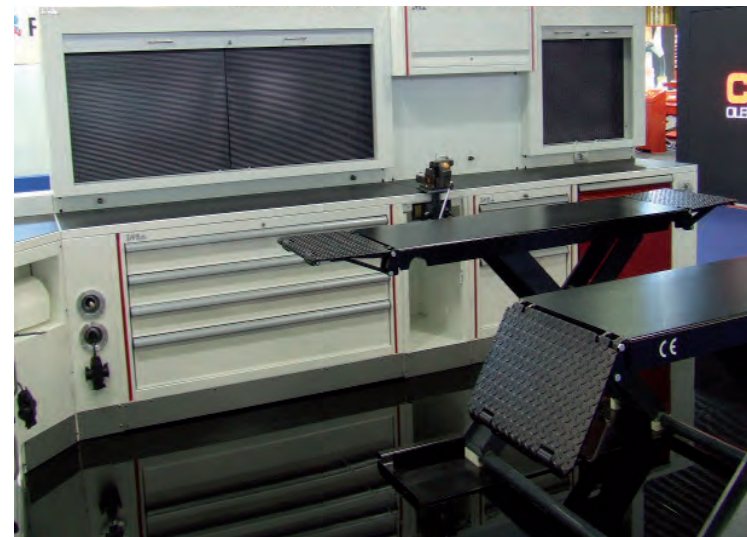

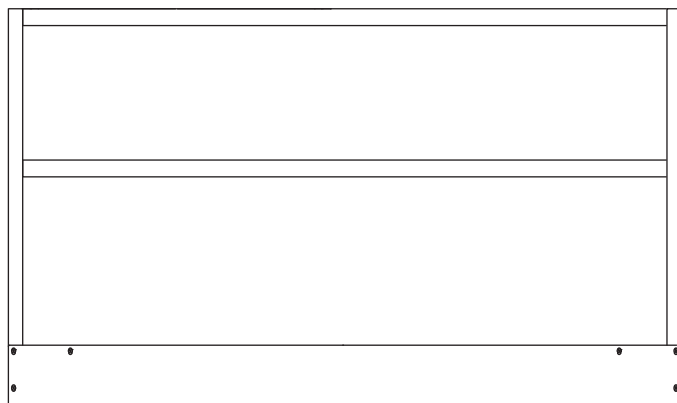

EQMRO.1606

Modulo L1600 con ripiano a giorno

Cabinet L1600 with open shelf

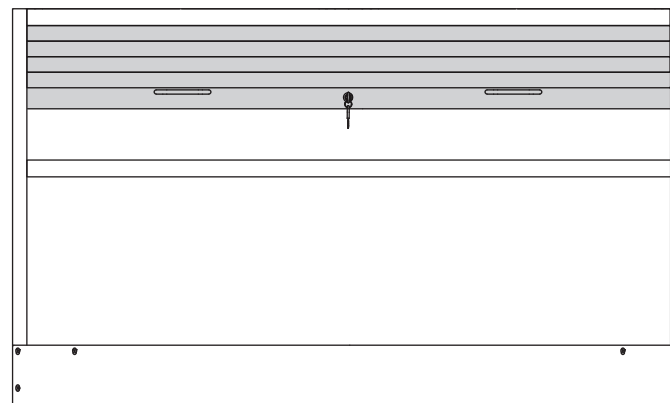

EQMRT.1606

Modulo L1600 con tapparella avvolgibile e ripiano a giorno

Cabinet L1600 with roller shutter and open shelf



Quad AutoRex - Varese, Italia

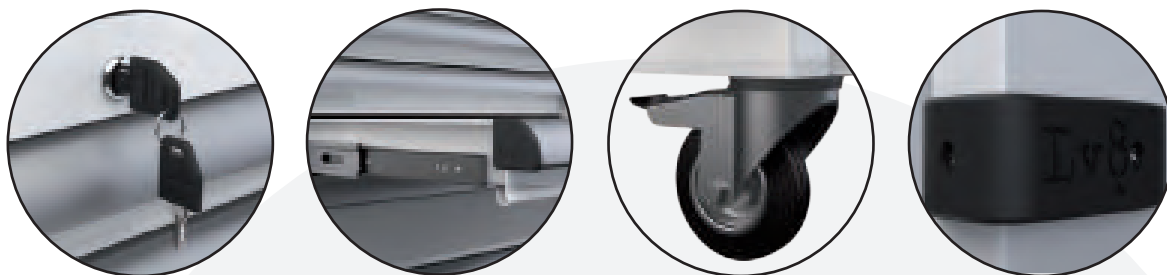

**STRUTTURA DI LAMIERA
ELETTOZINCATA 1,5 MM
VERNICIATA A
POLVERE EPOSSIDICA**

*ELECTRO-GALVANIZED
SHEET METAL
STRUCTURE 1.5 MM
EPOXY POWDER COATED*

**SERRATURE
A CHIAVE
KEY LOCK**

**GUIDE
AD ALTA PORTATA
HIGH CAPACITY
SLIDES**

**MANIGLIE IN ALLUMINIO
ESTRUSO SPAZZOLATO
E ANODIZZATO
EXTRUDED BRUSHED
ALUMINIUM HANDLES**

**RUOTE OMNIDIREZIONALI CON
FRENO INTEGRATO
OMNIDIRECTIONAL-WHEELS WITH
INTEGRATED BRAKES**

MODULE 800

mm 800

**H
DRAWER**
75 mm



W 587 mm
D 400 mm
KG 50

**H
DRAWER**
150 mm

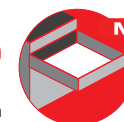

W 615 mm
D 540 mm
KG 100

**H
DRAWER**
250 mm



W 615 mm
D 540 mm
KG 100

**H
DRAWER**
300 mm



W 615 mm
D 540 mm
KG 100

**H
DRAWER**
400 mm



W 615 mm
D 540 mm
KG 200

800
mm

1200
mm

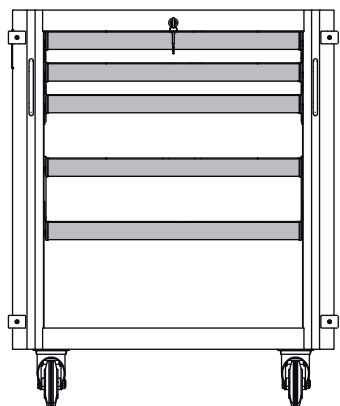

75 mm	50 kg
75 mm	50 kg
150 mm	50 kg
150 mm	50 kg
250 mm	50 kg

EQM5K.7605

Modulo Carrello 5 cassetti integrato con piano di lavoro in legno antiolio
Integrated under table 5 drawer trolley with oil-resistant wooden worktop

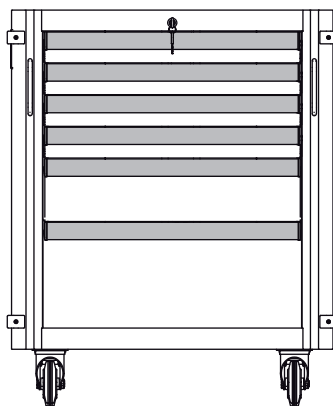

75 mm	50 kg
75 mm	50 kg
75 mm	50 kg
75 mm	50 kg
150 mm	50 kg
250 mm	50 kg

EQM6K.7605

Modulo Carrello 6 cassetti integrato con piano di lavoro in legno antiolio
Integrated under table 6 drawer trolley with oil-resistant wooden worktop

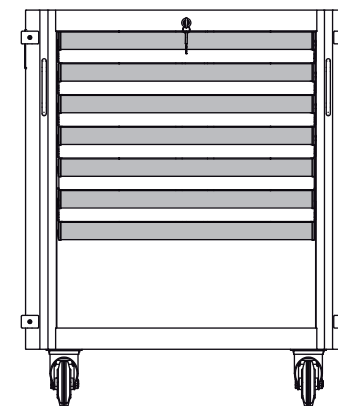

75 mm	50 kg
75 mm	50 kg
75 mm	50 kg
75 mm	50 kg
75 mm	50 kg
250 mm	50 kg

EQM7K.7605

Modulo Carrello 7 cassetti integrato con piano di lavoro in legno antiolio
Integrated under table 7 drawer trolley with oil-resistant wooden worktop

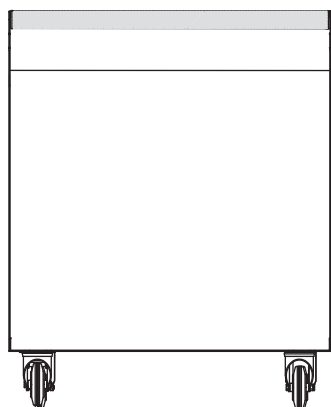

EQMSK.7605

Carrello LV8 sotto piana L760 PS00 per spazzatura differenziata a 2 posti sacco senza sportello frontale

Under table trolley for separate rubbish collection, 2 compartments without front door

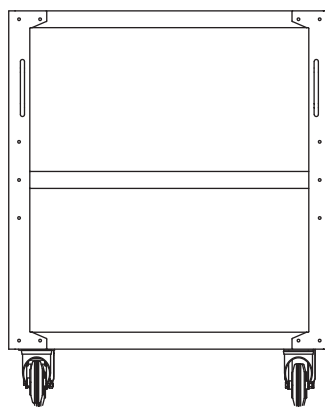

EQC3R.7605

Carrello a tre ripiani sottopiana
Under table trolley - 3 shelves

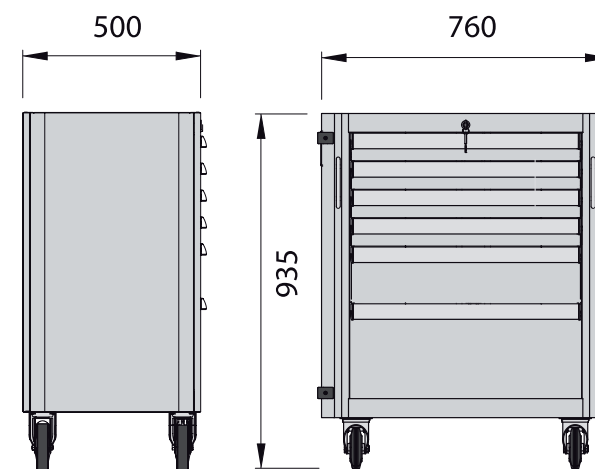

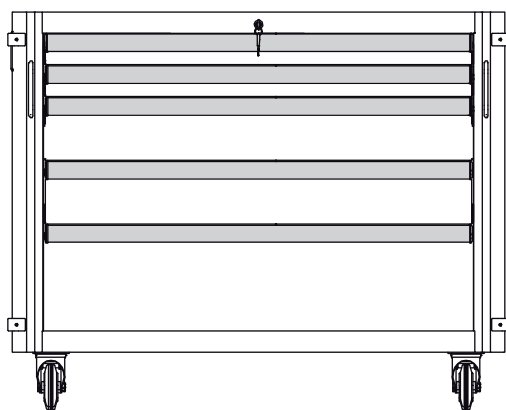

75 mm	100 kg
75 mm	100 kg
150 mm	150 kg
150 mm	150 kg
250 mm	150 kg

EQM5K.1105

Modulo Carrello 5 cassetti integrato con piano di lavoro in legno antioilo
Integrated under table 5 drawer trolley with oil-resistant wooden worktop

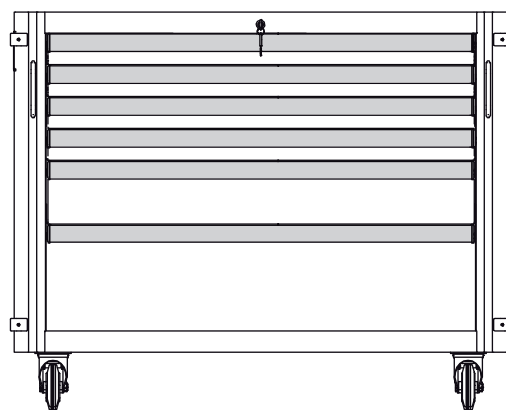

75 mm	100 kg
75 mm	100 kg
75 mm	100 kg
75 mm	100 kg
150 mm	150 kg
250 mm	150 kg

EQM6K.1105

Modulo Carrello 6 cassetti integrato con piano di lavoro in legno antioilo
Integrated under table 6 drawer trolley with oil-resistant wooden worktop

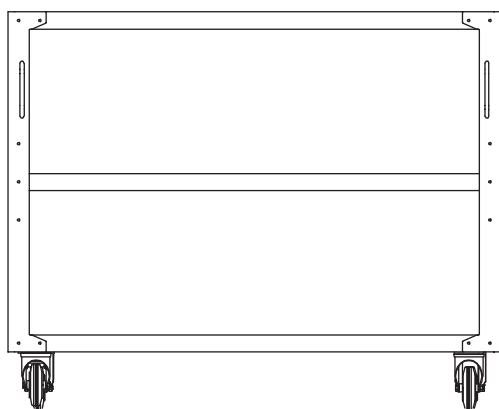

EQC3R.1105

Carrello a tre ripiani sottopiana larghezza 2 moduli
Under table 3 shelf trolley, 2 modules in length

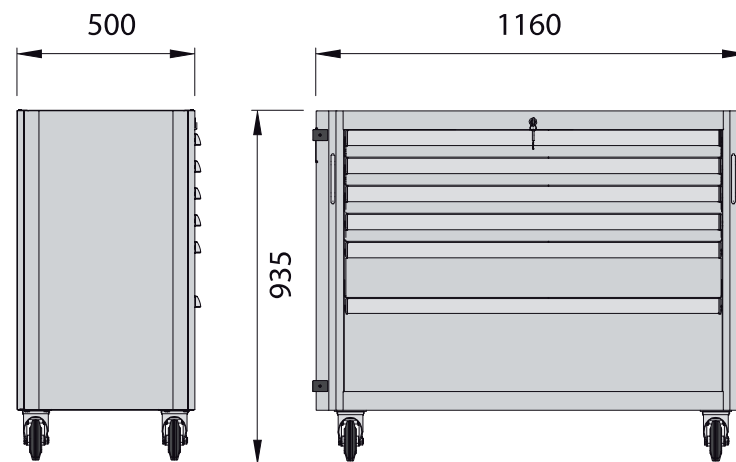



 **YAMAHA**

PIANE
WORKTOPS



100%
made In
ITALY



100%
made in



QUBE_36

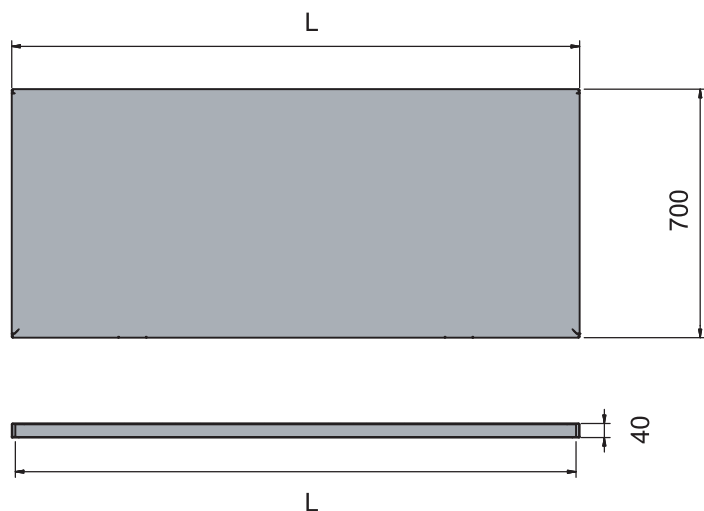
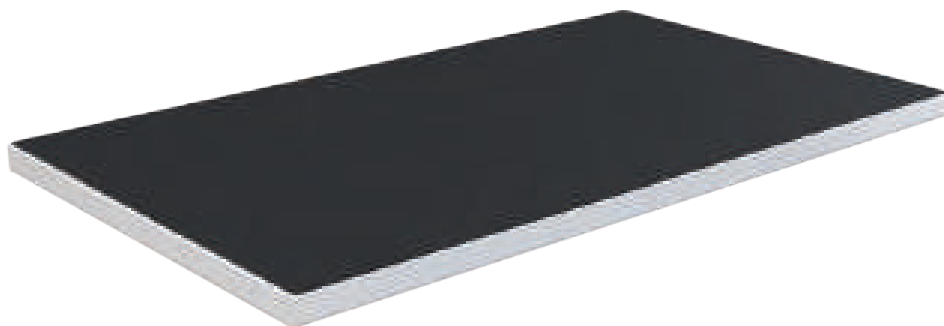

Piane Worktops

Lamiera verniciata a polvere epossidica
epoxy powder coated
sheet metal

EQPO807

(L800 P700 H40)
Piana 800x700
Worktop 800x700

EQP1207

(L1200 P700 H40)
Piana 1200x700
Worktop 1200x700

EQPO1607

(L1600 P700 H40)
Piana 1600x700
Worktop 1600x700

EQPO2007

(L2000 P700 H40)
Piana 2000x700
Worktop 2000x700

EQBP0807L

(L800 P700 H40)
Piana 800x700 con scasso lavandino
Worktop 800x700 with sink hole

EVOILO2

Vasca solo olio L450 P450 con griglia
da incassare sul piano di lavoro.
Ferro verniciato
Oil drain tank for Worktop.
Powder coated steel

Also Available in INOX Stainless steel Worktops

EQPO807IX

(L800 P700 H40)
Piana 800x700 INOX
INOX Worktop 800x700

EQP1207IX

(L1200 P700 H40)
Piana 1200x700 INOX
INOX Worktop 1200x700

EQPO1607IX

(L1600 P700 H40)
Piana 1600x700 INOX
INOX Worktop1600x700





EQPO2007IX

(L2000 P700 H40)
Piana 2000x700 INOX
INOX Worktop 2000x700

EQPKA1IX

(L965 P965 H40)
Piana angolo 90° 965x965 INOX
incluso kit gamba sostegno
+ kit cornici fissaggio
Corner Table 90° 965x965
INOX included rear leg kit
plus fixing/molding kit

DIMENSIONI

 800 mm	P 700 mm H 40 mm
 1200 mm	P 700 mm H 40 mm
 1600 mm	P 700 mm H 40 mm
 2000 mm	P 700 mm H 40 mm

Piane in legno Wooden worktops

EQP2007L

(L2000 P700 H40)

Piana in Legno 2000 verniciato

Painted wooden worktop 2000x700

Piane per isola Isle worktops

EQPKI1

(L1024 P862 H40)

Kit Piano raccordo isola 1024x862 inclusi due tamponamenti
bassi ciechi con fissaggi

Connecting worktop for peninsula 1024x862 including two blind
front closing panels and fixing/molding kit

EQP2007I

(L2000 P600 H40)

Piana 2000x600 per isola

Isle worktops 2000x600

Piane ad angolo Corner worktops

EQPKA1

(L965 P965 H40)

Kit Piano ad angolo 90° 965x965 incluso kit gamba sostegno + kit 2 cornici fissaggio
Kit Corner Table 90° 965x965 including rear leg kit plus fixing/molding kit

EQPKA1L

(L965 P965 H40)

Kit Piana angolo 90° 965x965 CON PREDISPOSIZIONE per lavandino (escluso) con
kit gamba + kit 2 cornici fissaggio

Kit Corner Table 90° 965x965 for hand wash (not included) including rear leg kit plus
fixing/molding kit

EQTAO1

Kit Elemento verticale inferiore tamponamento angolo cieco
Bottom vertical closing panel kit for blind corner table.

EQTAO2

Kit Elemento verticale inferiore tamponamento angolo porta carta
Paper holder front closing panel for corner table.

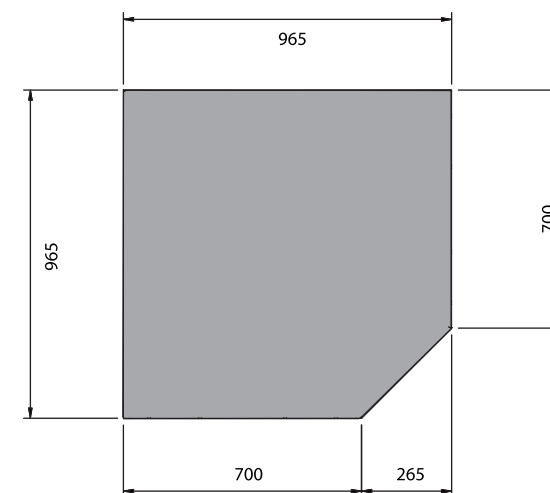



QUBE_39

COPERTURE PIANI

WORKTOP COVERINGS



100%
made in
ITALY



100%
made in



QUBE_40



Copertura in ABS per piano
Worktop ABS cover

EQABS.0807

Piano in Abs anti olio/anti Petrol 800X700 per piana L800
Petrol- and oil-resistant ABS cove 800X700

L790 P690 H3

EQABS.1207

Piano in Abs anti olio/anti Petrol 1200X700 per piana L1200
Petrol- and oil-resistant ABS cover 1200X700

L1190 P69 H3

EQABS.1607

Piano in Abs anti olio/anti Petrol 1600X700 per piana L1600
Petrol- and oil-resistant ABS cover 1600X700

L1590 P69 H3

EQABS.2007

Piano in Abs anti olio/anti Petrol 2000X700 per piana L2000
Petrol- and oil-resistant ABS cover 2000X700

L1990 P690 H3

EQABS.A1

Piano in Abs anti olio/anti Petrol 965X965 per piana ad angolo
Petrol- and oil-resistant ABS cover 965X965

L955 P955 H3



Copertura in resina per piano
Worktop resin cover

EQPRO.0807

Piano in resina anti-olio/anti-petrol sp 8mm 800 con angoli smussati
Petrol- and oil-resistant resin cover sp 8mm 800 with rounded corners

L800 P700 H8

EQPRO.1207

Piano in resina anti-olio/anti-petrol sp 8mm 1200 con angoli smussati
Petrol- and oil-resistant resin cover sp 8mm 1200 with rounded corners

L1200 P700 H8

EQPRO.1607

Piano in resina anti-olio/anti-petrol sp 8mm 1600 con angoli smussati
Petrol- and oil-resistant resin cover sp 8mm 1600 with rounded corners

L1600 P700 H8

EQPRO.2007

Piano in resina anti-olio/anti-petrol sp 8mm 2000 con angoli smussati
Petrol- and oil-resistant resin cover sp 8mm 2000 with rounded corners

L2000 P700 H8

EQPRO.A1

Piano in resina anti-olio/anti-petrol sp 8mm 965X965 per piana ad angolo
Petrol- and oil-resistant resin cover sp 8mm 965x965 with rounded corners

L965 P965 H8



Copertura in resina per carrello
Trolley resin cover

EQPRO.7605

Piano in resina anti-olio/anti-petrol sp 8mm 800x500 per modulo carrello
Petrol- and oil-resistant resin cover 8mm 800x500 with rounded corners

L760 P500 H8

TAMPONAMENTI

BACK PANELS



100%
made in
ITALY



100%
made in
Lv8

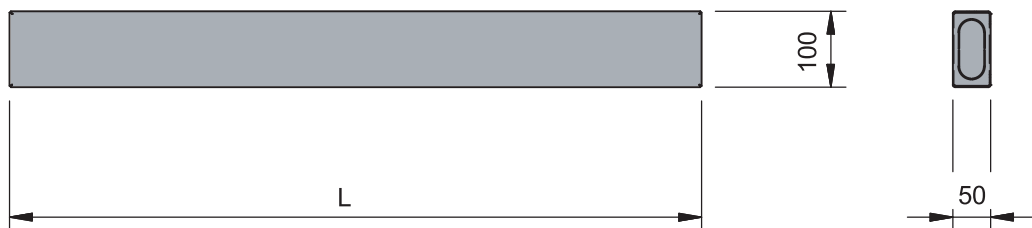

EQTP108

(L800 P50 H100)

Pannello tamponamento fondo 800 h100 cieco

Blind bottom closing panel 800 h100

EQTP112

Pannello tamponamento fondo 1200 h100 cieco

Blind bottom closing panel 1200 h100

EQTP116

Pannello tamponamento fondo 1600 h100 cieco

Blind bottom closing panel 1600 h100

EQTP120

(L2000 P50 H100)

Pannello tamponamento fondo 2000 h100 cieco

Blind bottom closing panel 2000 h100

EQTP108.1C

Pannello tamponamento fondo 800 h100 1 presa corrente (esclusa)

Bottom closing panel 800 h100 1 eletric socket (not included)

EQTP112.1C

(L1200 P50 H100)

Pannello tamponamento fondo 1200 h100 cieco

Blind bottom closing panel 1200 h100

EQTP116.1C

(L1600 P50 H100)

Pannello tamponamento fondo 1600 h100 cieco

Blind bottom closing panel 1600 h100

EQTP120.1C

Pannello tamponamento fondo 2000 h100 1 presa corrente (esclusa)

Bottom closing panel 2000 h100 1 eletric socket (not included)

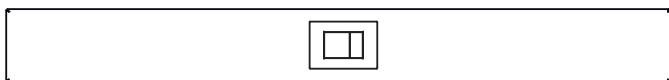

EQTP108.1C1A

Pannello tamponamento fondo 800 h100 1 presa corrente + 1 aria (escluse)

Bottom closing panel 800 h100 1 eletric socket + 1 air (not included)

EQTP112.1C1A

Pannello tamponamento fondo 1200 h100 2 prese corrente (escluse)

bottom closing panel 1200 h100 2 eletric socket (not included)

EQTP116.1C1A

Pannello tamponamento fondo 1600 h100 1 presa corrente + 1 aria (escluse)

Bottom closing panel 1600 h100 1 eletric socket + 1 air (not included)

EQTP120.1C1A

Pannello tamponamento fondo 2000 h100 2 presa corrente + 1 aria (escluse)

Bottom closing panel 2000 h100 1 eletric socket + 1 air (not included)



EQTP112.2C

Pannello tamponamento fondo 1200 h100 2 prese corrente (escluse)

Bottom closing panel 1200 h100 2 eletric socket (not included)

EQTP120.2C

Pannello tamponamento fondo 2000 h100 2 presa corrente (esclusa)

Bottom closing panel 2000 h100 1 eletric socket (not included)





EQTP116.2C

Pannello tamponamento fondo 1600 h100 2 presa corrente

Bottom closing panel 1600 h100 2 eletric socket



DIMENSIONI

 800 mm	P 50 mm H 100 mm
 1200 mm	P 50 mm H 100 mm
 1600 mm	P 50 mm H 100 mm
 2000 mm	P 50 mm H 100 mm

EQTP1A1

(L965 P50 H100-L915 P50 H100)

Kit tamponamento angolo h100 (2 pezzi)

Corner kit closing panel h100 (2pcs)

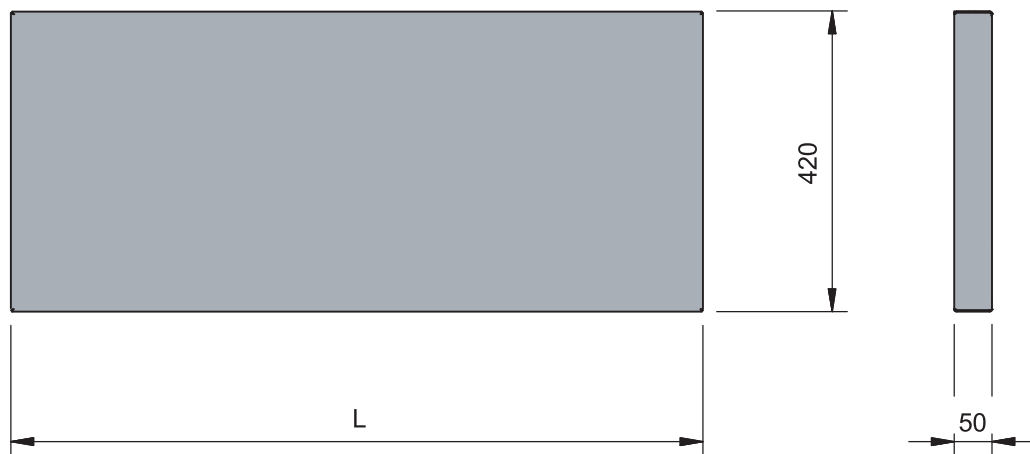

DIMENSIONI	
 800 mm	P 50 mm H 420 mm
 1200 mm	P 50 mm H 420 mm
 1600 mm	P 50 mm H 420 mm
 2000 mm	P 50 mm H 420 mm

EQTP408

(L800 P 50 H420)

Pannello tamponamento fondo 800 h420 cieco

Bottom closing panel 800 h420

EQTP412

(L1200 P50 H420)

Pannello tamponamento fondo 1200 h420 cieco

Blind bottom closing panel 1200 h420

EQTP408.1C

Pannello tamponamento fondo 800 h420 cieco

Blind bottom closing panel 800 h420

EQTP412.1C

Pannello tamponamento fondo 1200 h420 1 presa corrente (esclusa)

Bottom closing panel 1200 h420 1 electric socket (not included)

EQTP408.1C1A

Pannello tamponamento fondo 800 h420 1 presa corrente + 1 aria (escluse)

Bottom closing panel 800 h420 1 electric socket + 1 air (not included)

EQTP412.1C1A

Pannello tamponamento fondo 1200 h420 1 presa corrente + 1 aria (escluse)

Bottom closing panel 1200 h420 1 electric socket + 1 air (not included)

EQTP408.2C

Pannello tamponamento fondo 800 h420 2 prese corrente (escluse)

Bottom closing panel 800 h420 2 electric socket (not included)

EQTP412.2C

Pannello tamponamento fondo 1200 h420 2 prese corrente (escluse)

Bottom closing panel 1200 h420 2 electric socket + 1 air (not included)

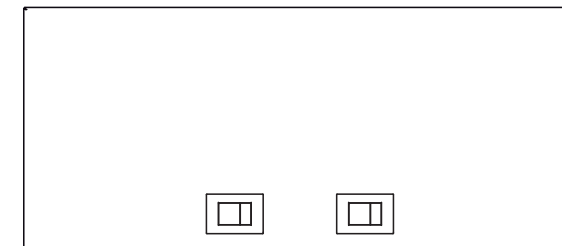
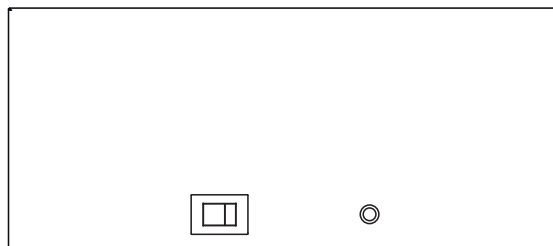
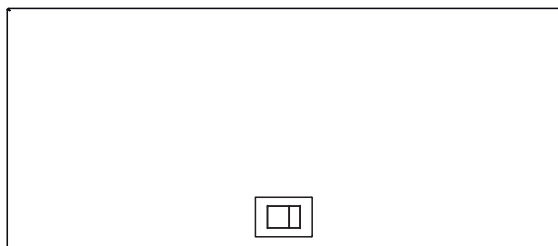

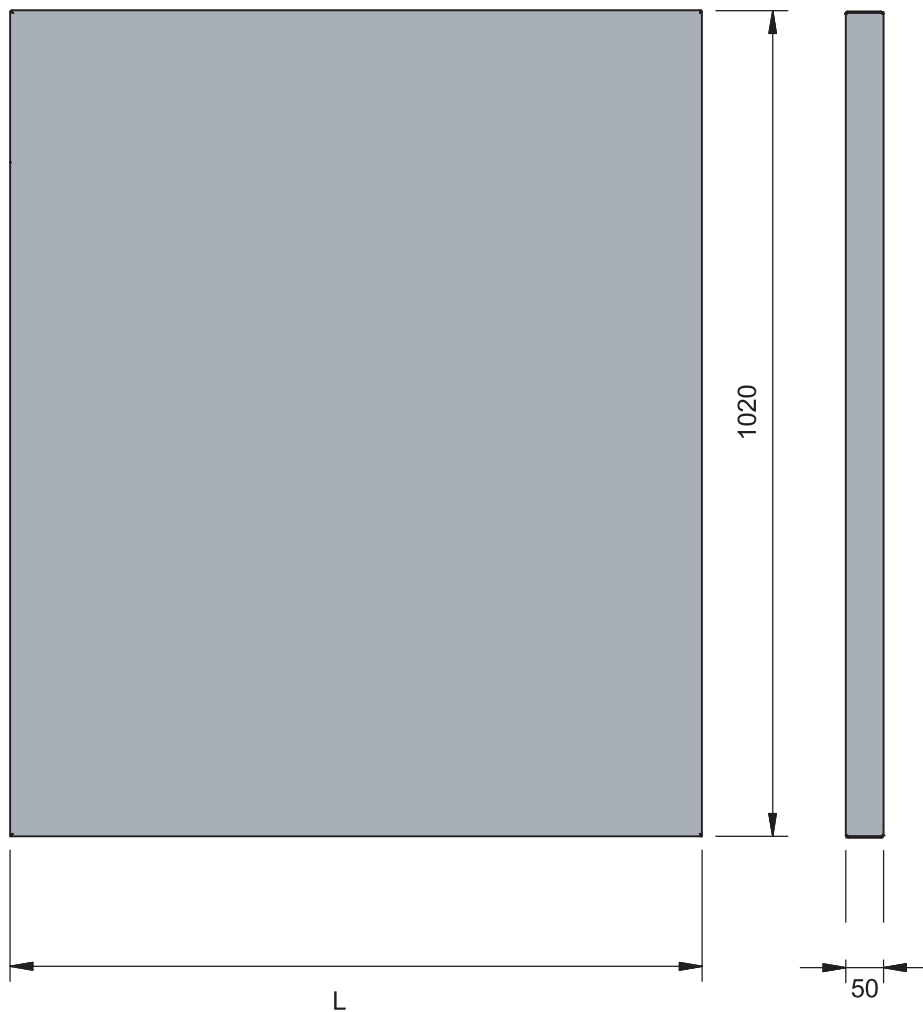

EQTP1008

(L800 P50 H1020)

Pannello tamponamento fondo 800 h1020 cieco

Blind bottom closing panel 800 h1020

EQTP1012

(L1200 P50 H1020)

Pannello tamponamento fondo 1200 h1020 cieco

Blind bottom closing panel 1200 h1020

EQTP1016

(L1600 P50 H100)

Pannello tamponamento fondo 1600 h1020 cieco

Blind bottom closing panel 1600 h1020





EQTP1020

(L2000 P50 H100)

Pannello tamponamento fondo 2000 h1020 cieco

Blind bottom closing panel 2000 h1020

DIMENSIONI

 800 mm	P 50 mm H 1020 mm
 1200 mm	P 50 mm H 1020 mm
 1600 mm	P 50 mm H 1020 mm
 2000 mm	P 50 mm H 1020 mm

EQTP1008.1C

Pannello tamponamento fondo 800 h1020 1 presa corrente (esclusa)
Bottom closing panel 800 h1020 1 electric socket (not included)

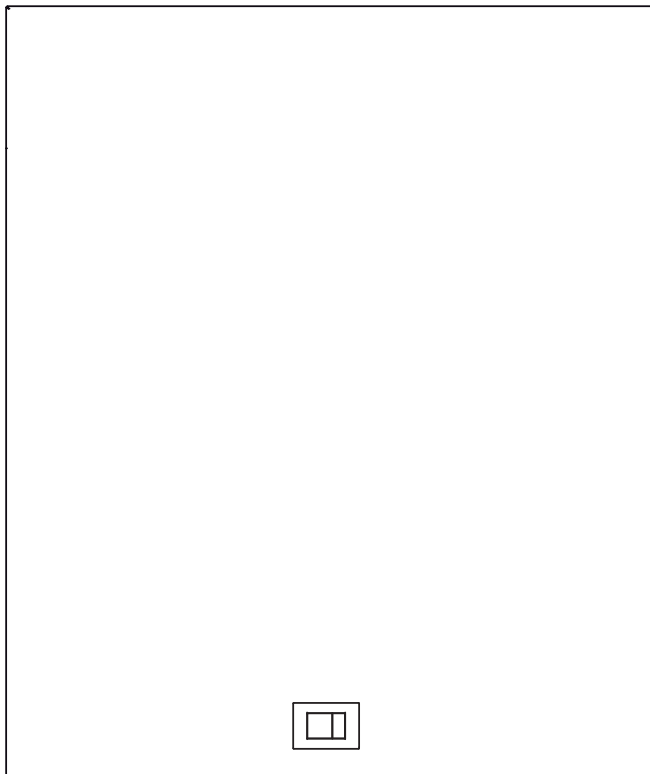

EQTP108.1C1A

Pannello tamponamento fondo 800 h1020 1 presa corrente + 1 aria (escluse)
Bottom closing panel 800 h1020 1 electric socket +1 air (not included)

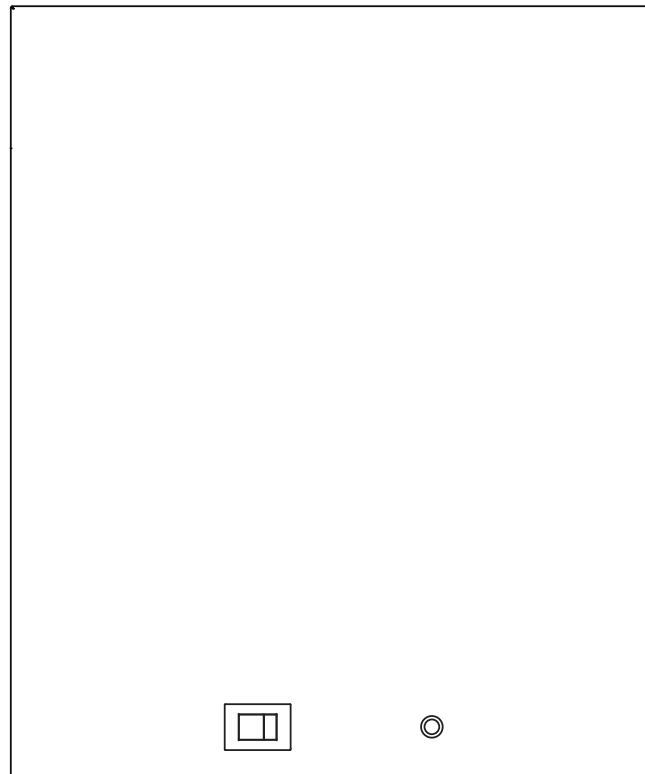



QUBE_47

MODULI SUPERIORI

UPPER CABINETS

▲8

Q **U**
B **E**

100%
made in
ITALY



100%
made in
LV8

QUBE_48

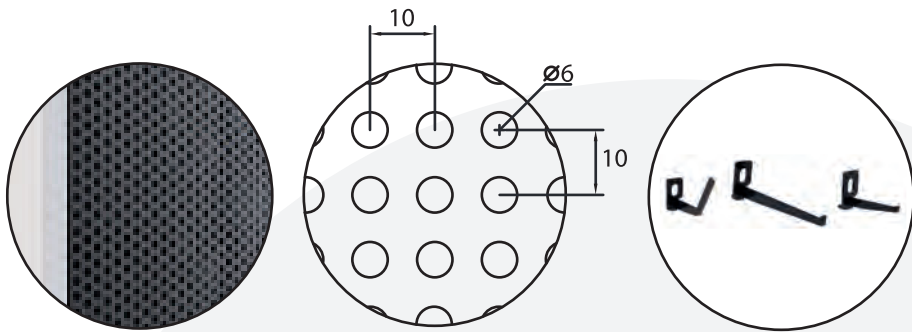

EQAT 1G.KG01

Kit ganci x utensili vari 100pz. in FE zincato
 con tassello e vite. 3 misure
 100pz hooks kit in galvanised steel

SERRATURE A CHIAVE KEY LOCK

**STRUTTURA DI LAMIERA
 ELETTROZINCATA 1,2 MM
 VERNICIATA A
 POLVERE EPOSSIDICA**
*ELECTRO-GALVANIZED
 SHEET METAL
 STRUCTURE 1.2 MM
 EPOXY POWDER COATED*

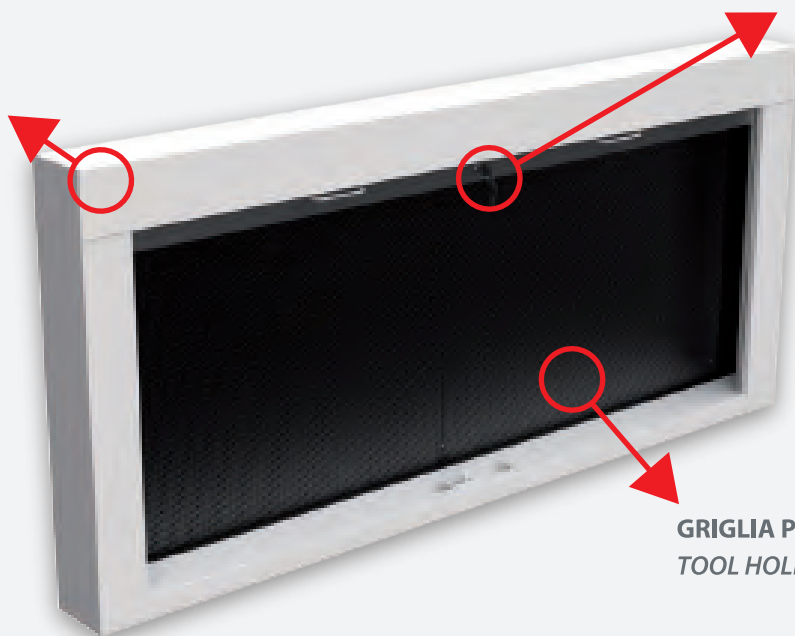

**GRIGLIA PORTAUTENSILI
 TOOL HOLDER WALL PANEL**

DIMENSIONI

	P 160 mm H 920 mm
1200 mm	
	P 160 mm H 920 mm
2000 mm	

1200
mm

2000
mm

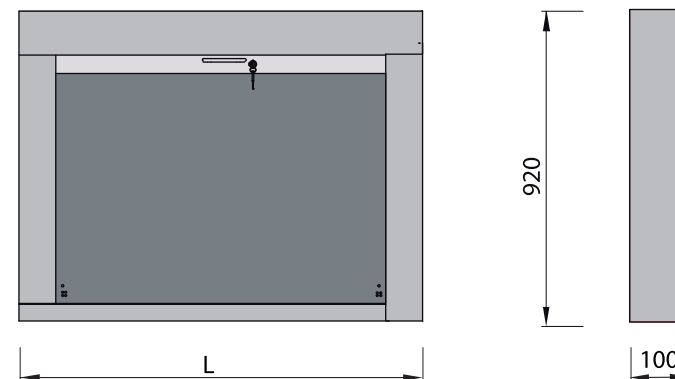

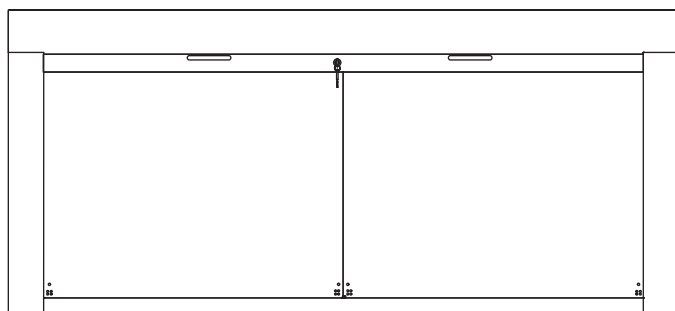

EQAT.2001

Porta utensili a muro chiuso con serranda alluminio

Wall panel with aluminum shutter

L2000 P160 H920

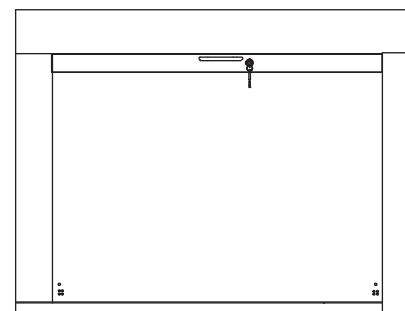

EQAT.1201

Porta utensili a muro chiuso con serranda alluminio

Wall panel with aluminum shutter

L1200 P160 H920



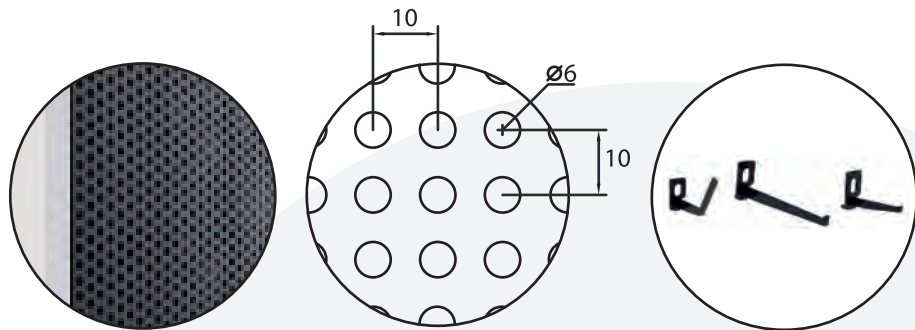

EQAT 1G.KGO1



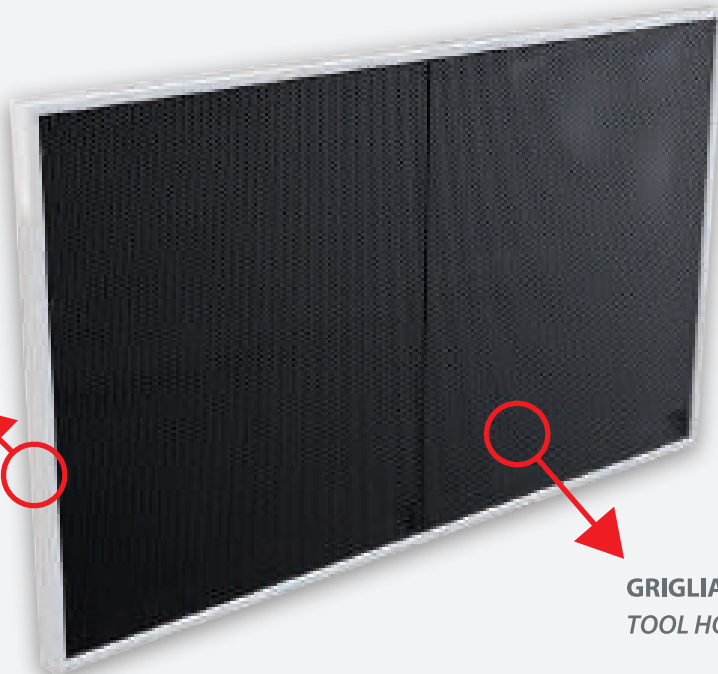

Kit ganci x utensili vari 100pz. in FE zincato
 con tassello e vite. 3 misure
 100pz hooks kit in galvanised steel

**STRUTTURA DI LAMIERA
 ELETTROZINCATA 1,5 MM
 VERNICIATA A
 POLVERE EPOSSIDICA**

*ELECTRO-GALVANIZED
 SHEET METAL
 STRUCTURE 1.5 MM
 EPOXY POWDER
 COATED*



**GRIGLIA PORTAUTENSILI
 TOOL HOLDER WALL PANEL**

DIMENSIONI	
 800 mm	P 50 mm H 920 mm
 1200 mm	P 50 mm H 920 mm
 2000 mm	P 50 mm H 920 mm
 2800 mm	P 50 mm H 920 mm

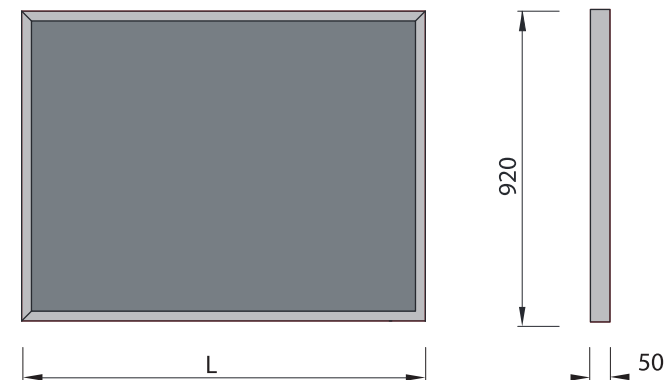

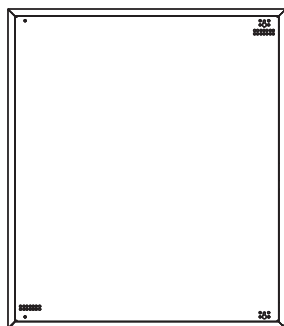

EQPU08

Porta utensili con griglia a giorno per banco
Tool holder grid - over worktop/counter
L800 P50 H 920

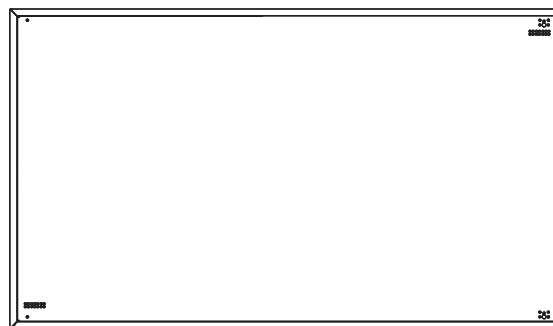

EQPU12

Porta utensili con griglia a giorno per banco
Tool holder grid - over worktop/counter
L1200 P50 H 920

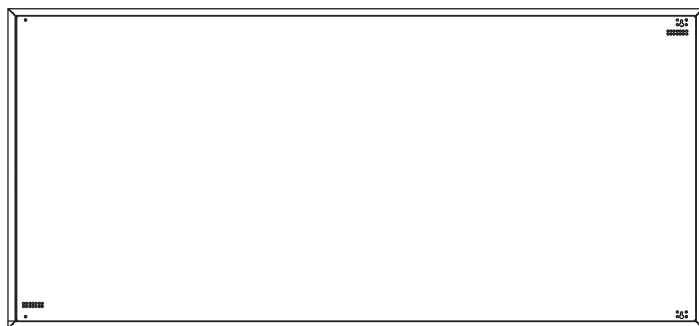

EQPU20

Porta utensili con griglia a giorno per banco
Tool holder grid - over worktop/counter
L2000 P50 H 920

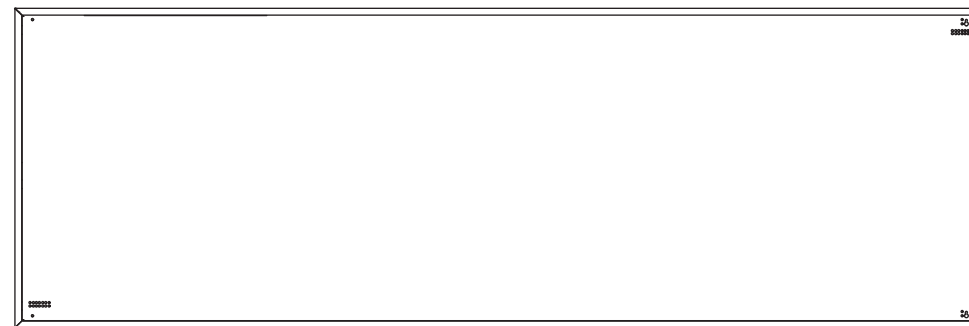

EQPU28

Porta utensili con griglia a giorno per banco
Tool holder grid - over worktop/counter
L2800 P50 H 920

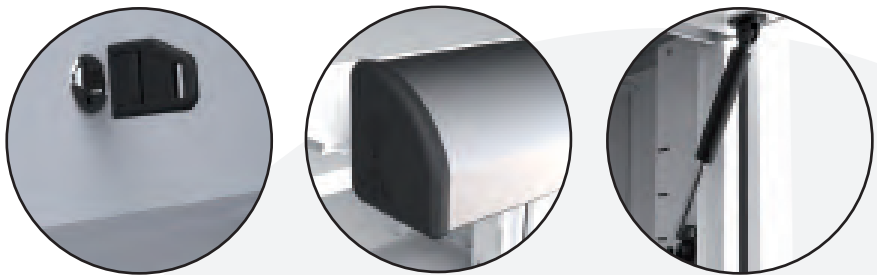

**STRUTTURA
DI LAMIERA
ELETTOZINCATA
1,2 MM
VERNICIATA A
POLVERE EPOSSIDICA**
*ELECTRO-GALVANIZED
SHEET METAL
STRUCTURE 1.2 MM
EPOXY POWDER COATED*

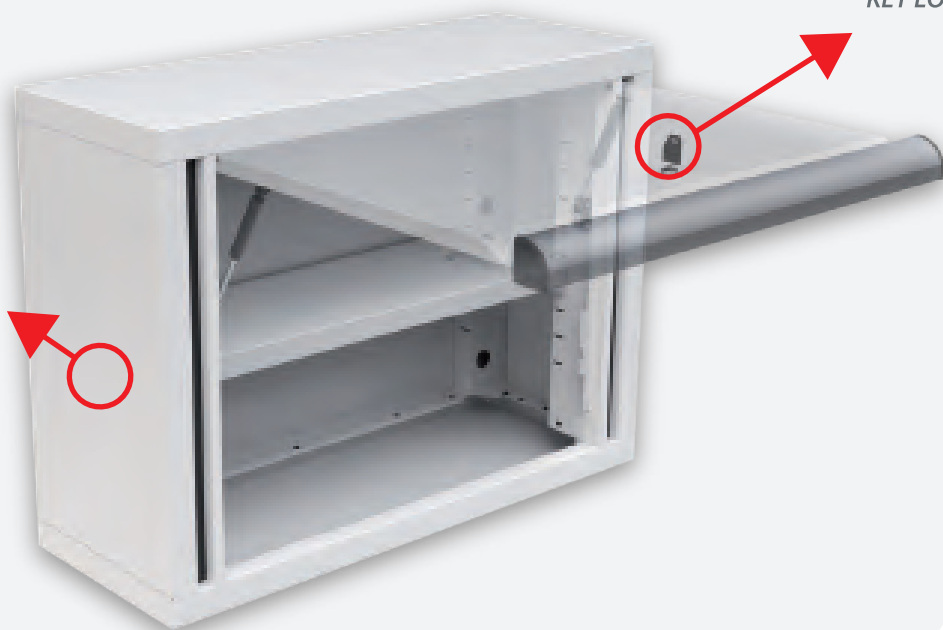

**SERRATURE
A CHIAVE
KEY LOCK**

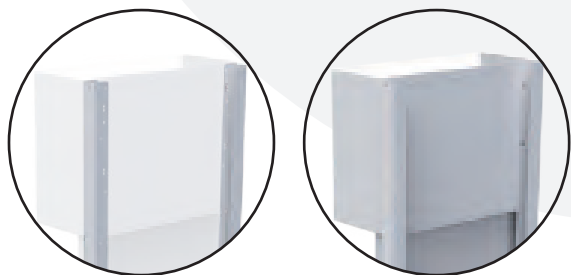

DIMENSIONI	
<p>L 800 mm</p>	<p>P 300 mm H 600 mm</p>
<p>L 1200 mm</p>	<p>P 300 mm H 600 mm</p>

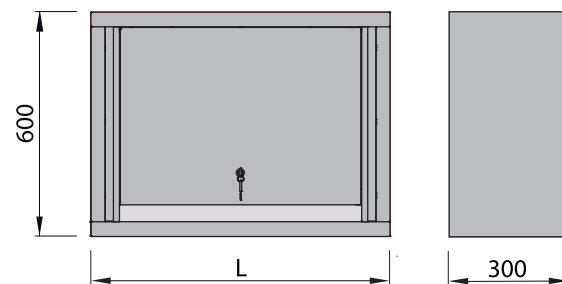

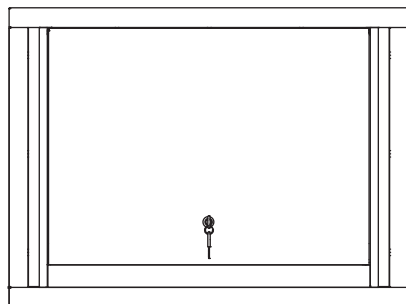

EQP108

Penisle a muro piccolo L800 P300 H600

Wall cabinet 800 mm

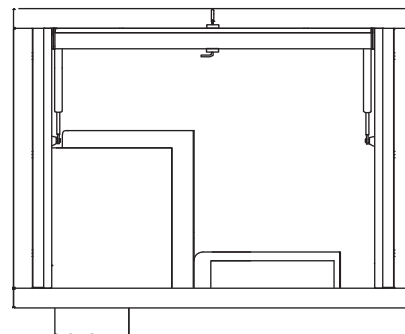

EQP108CG

Penisle a muro piccolo L800 P300 H600 con distributore carta e guanti

Wall cabinet 800 mm with paper and glove dispensers

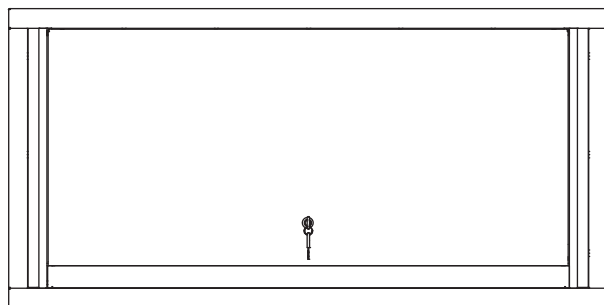

EQP112

Penisle a muro L1200 P300 H600

Wall cabinet 1200 mm

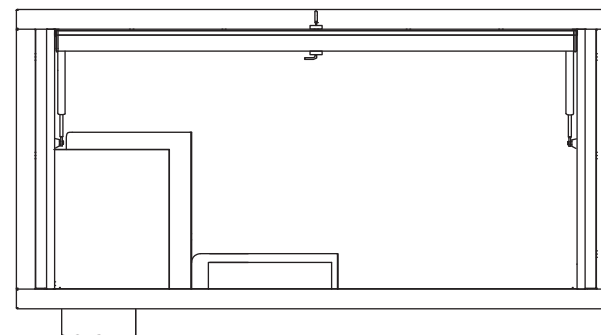

EQP112CG

Penisle a muro L1200 P300 H600 con distributore carta e guanti

Wall cabinet 1200 mm with paper and glove dispensers



STRUTTURE AUTOPORTANTI

SELF SUPPORTING STRUCTURES

 **QUBE**

100%
made in
ITALY



100%
made in

Lv8

QUBE_56



EQS01

Kit Montanti di sostegno autoportanti
Self supporting kit

ARMADI E SCAFFALI

CLOSET AND SHELF CABINETS

QUBE

100%
made in
ITALY



100%
made in
Lv8

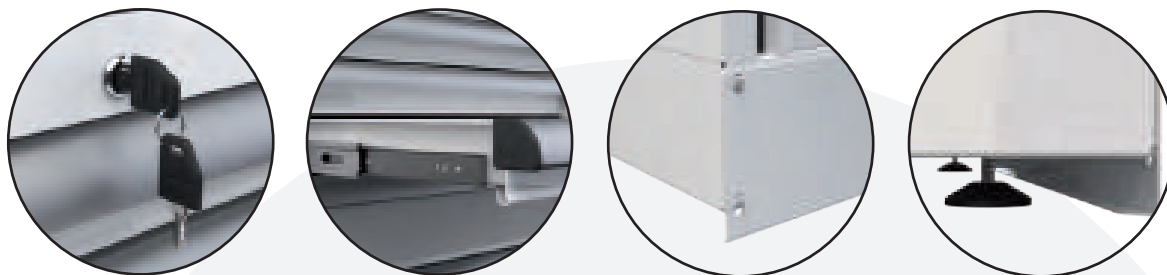

**STRUTTURA DI LAMIERA
ELETTOZINCATA
1,5 MM
VERNICIATA A
POLVERE EPOSSIDICA**
*ELECTRO-GALVANIZED
SHEET METAL
STRUCTURE 1.5 MM
EPOXY POWDER COATED*

**SERRANDA IN ALLUMINIO
ALUMINIUM SHUTTER**

**GUIDE
AD ALTA PORTATA
HIGH CAPACITY
SLIDES**

**BASI INTEGRATE
CON PIEDINI
REGOLABILI IN ALTEZZA**
*INTEGRATED BASES
WITH HEIGHT
ADJUSTABLE FEET*

**SERRATURE
A CHIAVE
KEY LOCK**

**RIPIANO REGOLABILE
ADJUSTABLE SHELF**

**MANIGLIE IN ALLUMINIO
ESTRUSO SPAZZOLATO
E ANODIZZATO**
*EXTRUDED BRUSHED
ALUMINIUM HANDLES*

DIMENSIONI

L
800 mm

**P 600 mm
H 2000 mm**

L
1200 mm

**P 600 mm
H 2000 mm**

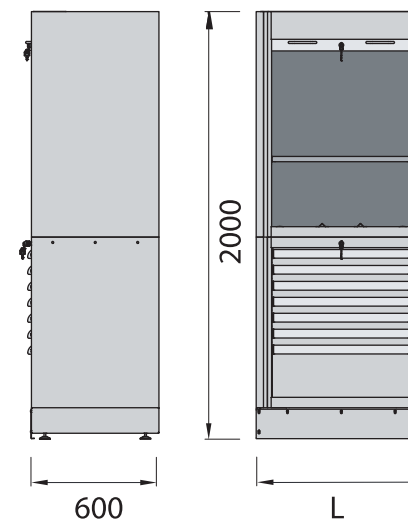

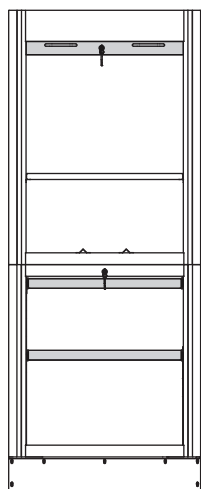

300 mm	100 kg
400 mm	200 kg

EQAT08.2C

Armadio con 2 cassetti e serranda in alluminio
2 drawer closet with aluminum shutter

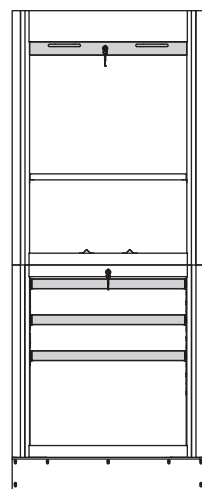

150 mm	100 kg
150 mm	100 kg
400 mm	200 kg

EQAT08.3C

Armadio con 3 cassetti e serranda in alluminio
3 drawer closet with aluminum shutter

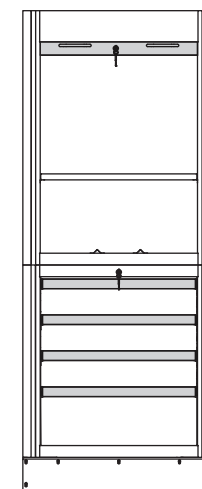

150 mm	100 kg
150 mm	100 kg
150 mm	100 kg
250 mm	100 kg

EQAT08.4C

Armadio con 4 cassetti e serranda in alluminio
4 drawer closet with aluminum shutter

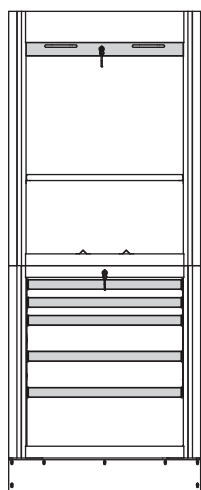

75 mm	100 kg
75 mm	100 kg
150 mm	100 kg
150 mm	100 kg
250 mm	100 kg

EQAT08.5C

Armadio con 5 cassetti e serranda in alluminio
5 drawer closet with aluminum shutter

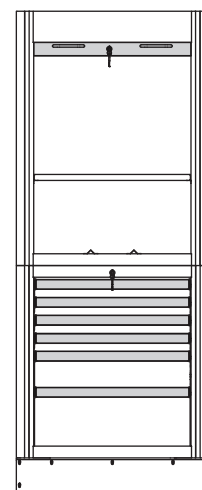

75 mm	100 kg
75 mm	100 kg
75 mm	100 kg
75 mm	100 kg
150 mm	100 kg
250 mm	100 kg

EQAT08.6C

Armadio con 6 cassetti e serranda in alluminio
6 drawer closet with aluminum shutter

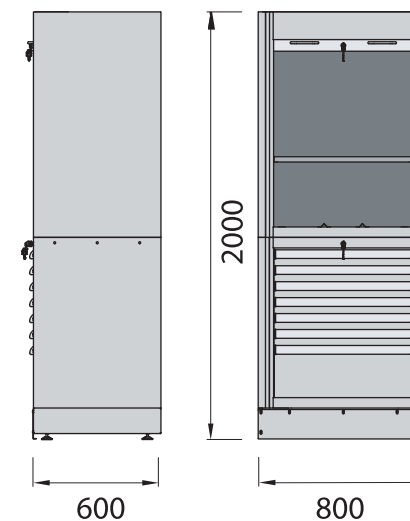

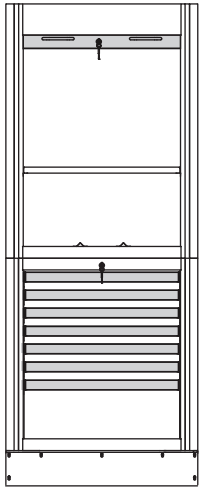

75 mm	100 kg
75 mm	100 kg
75 mm	100 kg
75 mm	100 kg
75 mm	100 kg
75 mm	100 kg
250 mm	100 kg

EGAT08.7C

Armadio con 7 cassetti e serranda in alluminio
7 drawer closet with aluminium shutter

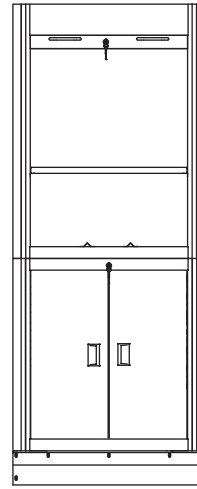

EGAT08.2A

Armadio a 2 ante e serranda in alluminio
2 door closet with aluminium roller shutter



Total Triumph - UK

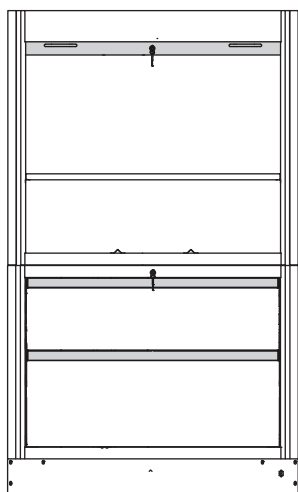

300 mm	150 kg
400 mm	300 kg

EQAT12.2C

Armadio con 2 cassetti e serranda in alluminio
2 drawer closet with aluminum shutter

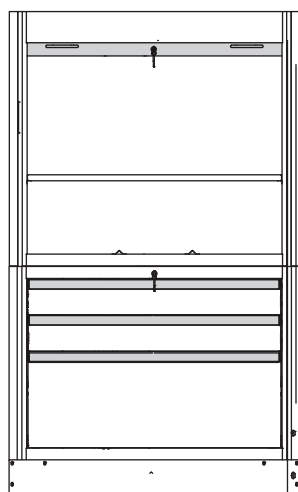

150 mm	150 kg
150 mm	150 kg
400 mm	300 kg

EQAT12.3C

Armadio con 3 cassetti e serranda in alluminio
3 drawer closet with aluminum shutter

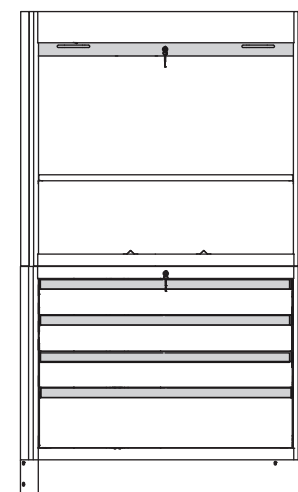

150 mm	150 kg
150 mm	150 kg
150 mm	150 kg
250 mm	150 kg

EQAT12.4C

Armadio con 4 cassetti e serranda in alluminio
4 drawer closet with aluminum shutter

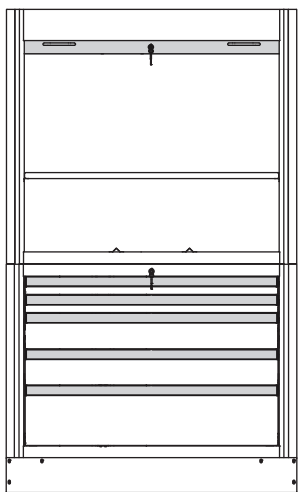

75 mm	180 kg
75 mm	180 kg
150 mm	150 kg
150 mm	150 kg
250 mm	150 kg

EQAT12.5C

Armadio con 5 cassetti e serranda in alluminio
5 drawer closet with aluminum shutter

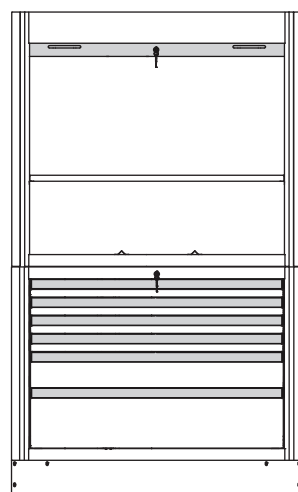

75 mm	180 kg
75 mm	180 kg
75 mm	180 kg
75 mm	180 kg
150 mm	150 kg
250 mm	150 kg

EQAT12.6C

Armadio con 6 cassetti e serranda in alluminio
6 drawer closet with aluminum shutter

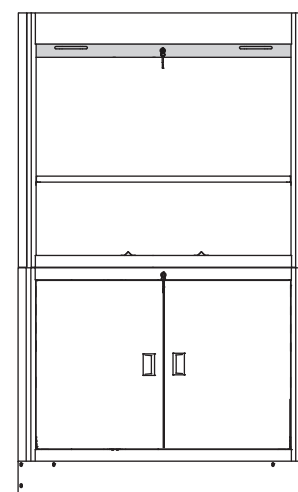

EQAT12.2A

Armadio 2 ante e serranda in alluminio
2 door closet with aluminum shutter



Fani Motors - Yamaha

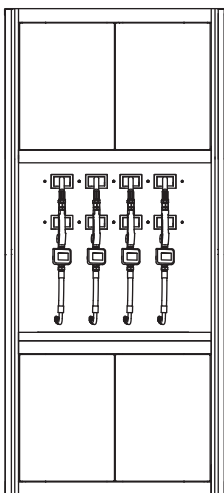

EQA001

Armadio distribuzione fluidi e servizi completo di 4 arrotolatori olio/acqua e 3 arrotolatori aria/elettrico/lampada

Oil - air and liquid distribution closet (max 4 oil reels + 3 air/electric/lamp reels).

**DISPONIBILE ANCHE
ALSO AVAILABLE**

EQA001.1

Armadio distribuzione fluidi e servizi escluso arrotolatori. Nr uscite max 7 da configurare

Oil - air and liquid distribution closet for reels not included. Number of reels on request (max 7)

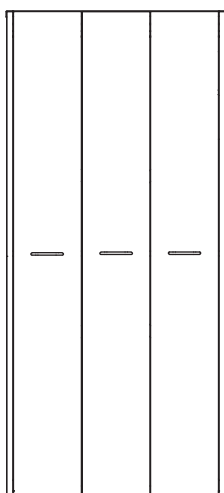

EQAF01

Armadio a 3 cassetti verticali con doppie griglie forate portautensili

Closet with 3 vertical drawers with double tool grids

**DISPONIBILE ANCHE
ALSO AVAILABLE**

EQAF02

Armadio a 4 cassetti verticali ad estrazione guidata con 8 griglie forate portautensili

Closet with 4 vertical drawers (with sliders) with double tool grids (8 grids in total)

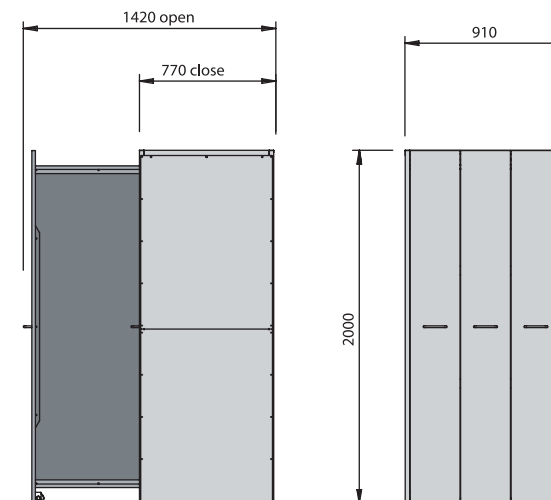

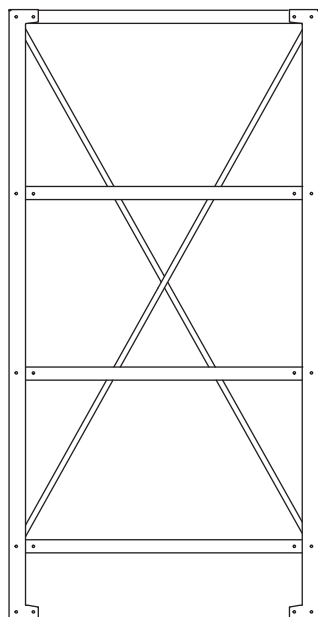
**EQSC0807**

Scaffale a 4 ripiani H2000 L800 P700

N°4 shelf module H2000 L800 P700

EQSC1207

Scaffale a 4 ripiani H2000 L1200 P700

N°4 shelf module H2000 L1200 P700

EQSC1607

Scaffale a 4 ripiani H2000 L1600 P700

N°4 shelf module H2000 L1600 P700

EQSC1607

Scaffale a 4 ripiani H2000 L2000 P700

N°4 shelf module H2000 L2000 P700

**EQABS.SC0807**

Abs anti-oil per ripiano scaffale 800x700

ABS oil resistant cover for shelf module 800x700

EQABS.SC1207

Abs anti-oil per ripiano scaffale 1200x700

ABS oil resistant cover for shelf module 1200x700

EQABS.SC1607

Abs anti-oil per ripiano scaffale 1600x700

ABS oil resistant cover for shelf module 1600x700

EQABS.SC2007

Abs anti-oil per ripiano scaffale 2000x700

ABS oil resistant cover for shelf module 2000x700



PARTI SPECIALI

SPECIAL PARTS



100%
made in
ITALY



100%
made in
LV8





EQBKA01

Kit 1 anta per chiusura 1 modulo
One door closing for 1 module
L800 P700 H930



EQBKA02

KIT 2 ANTE CHIUSURA
Two doors closing
L800 P700 H930



EQPCB01

Pannello in acciaio inossidabile
con vaschette alloggiamento batterie
Attrezzabile fino ad un massimo di 10 carica batterie
al piombo e litio
*Quadro elettrico e carica batterie (optional)
Stainless steel Wall Panel with shelves for batteries housing
Configurable up to 10 lead and lithium batteries chargers
*Distribution Cabinet and chargers (optional)



EQPP02

Schiena in lamiera per banco con struttura
autoportante h2000 largh 1024
Rear cover for half 2 modules bench + structure
H2000 L1024

EQPP01

Schiena in lamiera per 1 modulo con struttura
autoportante h2000 largh 800
Rear cover for one module + structure H2000
L800



EQAC13

Kit lavandino per angolo
Sink kit for corner worktop

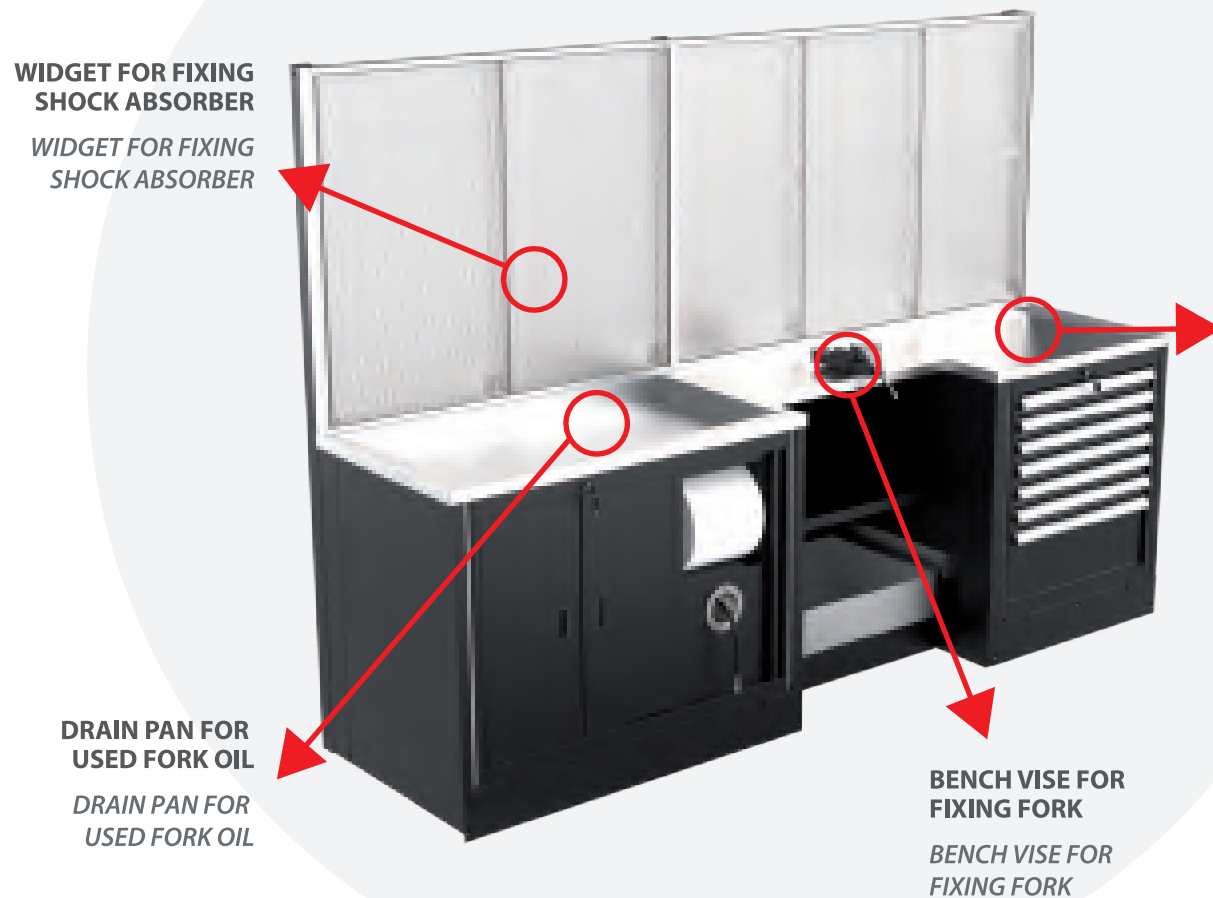
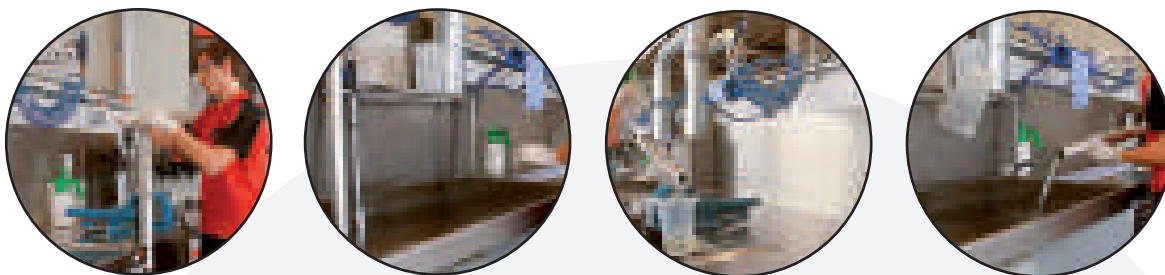

DIMENSIONI

H
985 mm

L 2800 mm
P 700 mm

H
2000 mm

L 2800 mm
P 760 mm

OPTIONAL

- Morsa Bench Vise
- Vasca Raccogli Olio Oil collecting Tray
- Kit ganci per sospensioni Suspension Hooks Kit

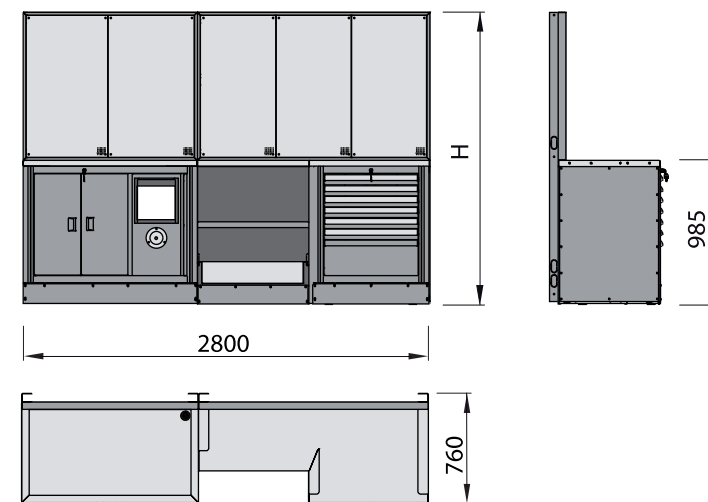

QUBE_68

BANCO SOSPENSIONI LV8

La prima workstation per lavorare su ogni tipo di sospensione motociclistica! Si tratta di una postazione di lavoro specifica progettata dai ns. tecnici e designer in collaborazione a uno dei più importanti produttori di ammortizzatori mondiali, 100% made in LV8. Le griglie e il piano di lavoro sono completamente in acciaio inox con vasca scolo olio autopulente. Il banco di lavoro è provvisto di mobiletto a 2 ante per immagazzinaggio olii, liquidi nuovi e dotato di tanica di raccolta dei liquidi esausti, zona centrale con ripiano a giorno per riporre caraffe e cilindri graduati, cassettera fissa per il contenimento degli utensili e di tutti i ricambi necessari. Gli optional : smonta ammortizzatori / smonta forcelle, 100% made in LV8 , morsa in acciaio forgiato utile per fissare lo strumento .

LV8 SUSPENSION WORKBENCH

The first workstation to operate on every kind of motorcycle suspension! It is been completely designed and created by our technicians in collaboration with one of the most important suspensions manufacturer, 100% made in LV8. The grids and the worktop are completely made of inox steel with shelf-washing oil tank. The workshop features are: 2 doors module to store oils, new liquids and equipped with an exhausted liquids tank, central zone with open shelf to store graduated carafes and cylindres, drawers cabinet to keep in tools and any kind of spare parts you may need. Optional features: shock-absorber and forks disassembler, 100% made in LV8, forged steel bench vise usefull for fixing the instrument.

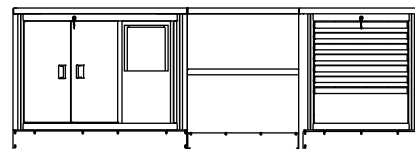

Banco per lavoro su sospensioni e motori con vasca e piano INOX

Suspension and Engine workbench with INOX plan and tank

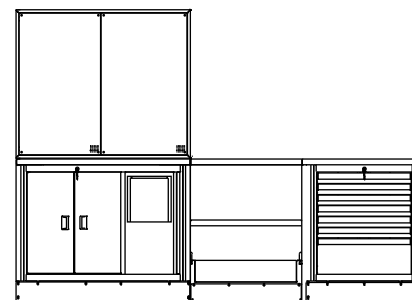

Banco per lavoro su sospensioni e motori con vasca e piano INOX dotato di griglia INOX sulla vasca e vaschetta estraibile raccogli olio sotto la morsa

Suspension and Engine workbench with INOX plan and tank featuring an INOX Tool Holder Grid on top of the tank, with extractable oil collecting tray under the bench vise

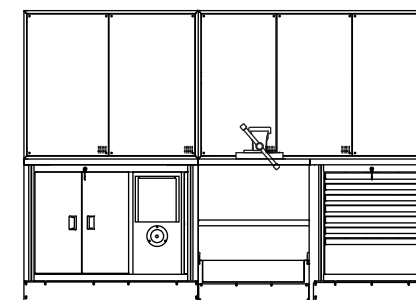

Banco per lavoro su sospensioni e motori con vasca e piano INOX dotato di griglie INOX sulla vasca e sul piano di lavoro con arrotolatore aria compressa vasca estraibile raccogli olio sotto la morsa

Suspension and Engine workbench with INOX plan and tank featuring an INOX Tool Holder Grid on top of the tank and the workplan, with compressed air reel and extractable oil collecting tray under the bench vise

KIT ILLUMINAZIONE LED

LED LIGHTING



100%
made in
ITALY



100%
made in
Lv8

QUBE_70

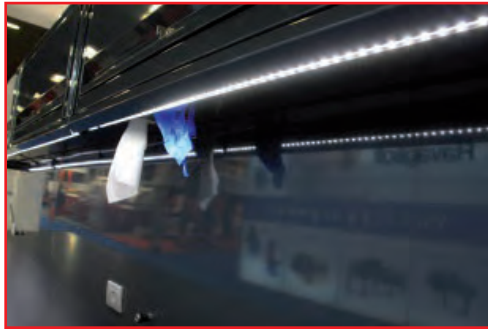
**EQKIL.20**

Kit illuminazione LED 24V per Porta utensili L2000 con serranda alluminio
Illumination kit LED 24v, upper cabinet, L2000 with aluminium shutters

EQKIL.08

Kit illuminazione LED 24V per Pensile L800 compreso copri luce front
Illumination kit LED 24v for wall units including front light coverale

EQKIL.10

Kit illuminazione LED 24V per Pensile L 1200 compreso copriluce frontale
Illumination kit LED 24v for wall units including front light cover



COMPONENTI PER IMPIANTISTICA ARIA COMPRESSA ED ELETTRICA

AIR AND ELECTRIC COMPONENTS



100%
made in
ITALY



100%
made in
Lv8

QUBE_72



EQAC-AR10

Arrotolatore aria con uscita M1/4"
Air hose reel with M1/4" exit



EQAC-ER10

Arrotolatore corrente 220V 1600W
con 3 prese shuko
Electric cable reel 220V 1600W
with 3 shuko sockets



EQAC-AC1

Kit attacco rapido aria compressa
Air pressure quick connection kit



EQAC-ESC3

Kit Presa di corrente protetto IP55 passo 503 (1
bipasso 16A + 1 Shuko 16A)
Electric socket kit IP55 (1 bipasso 16A + 1 Shuko
16A)



EQAC-ESI3

Kit Presa di corrente 2P+T 16A 230V
Electric socket kit 2P+T 16A 230V



EQAC-ESI1

Kit Presa di corrente 2P+T 16A 230V IP66
interbloccata con fusibili a bordo
Electric socket kit 2P+T 16A 230V IP66 -
interlocked with fuses



EQAC-ESI2

Kit Presa di corrente 3P+T 16A 400V IP66
interbloccata con fusibili a bordo
Electric socket kit 3P+T 16A 400V IP66 -
interlocked with fuses



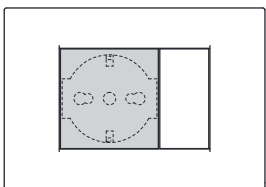

**DISPONIBILE
ANCHE
ALSO
AVAILABLE**

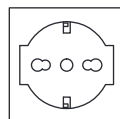

EQAC.ESC24
Kit presa di corrente 2P
Electric socket kit
Schuko/UNEL 16A+Falsopolo

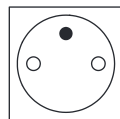

EQAC.ESC13
Kit presa di corrente FR 2P
Electric socket kit
+T13A + Falsopolo

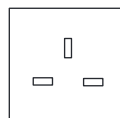

EQAC.ESC4
Kit presa di corrente UK 2P
Electric socket kit
+T13A + Falsopolo

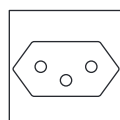

EQAC.ESC11
Kit presa di corrente SWISS 2P
Electric socket kit
+T13A + 1 Falsopolo

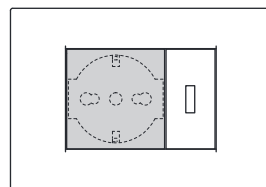

**DISPONIBILE
ANCHE
ALSO
AVAILABLE**

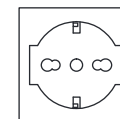

EQAC.ESC5
Kit presa di corrente 2P
Electric socket kit
Schuko/UNEL 16A+USB

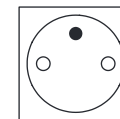

EQAC.ESC18
Kit presa di corrente FR 2P
Electric socket kit
+T13A + USB

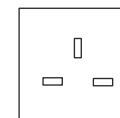

EQAC.ESC1
Kit presa di corrente UK 2P
Electric socket kit UK 2P
+T13A + USB

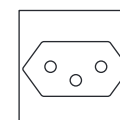

EQAC.ESC23
Kit presa di corrente SWISS 2P
Electric socket kit SWISS 2P
+T13A + 1 USB

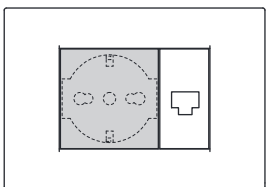

**DISPONIBILE
ANCHE
ALSO
AVAILABLE**

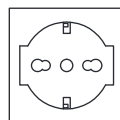

EQAC.ESC8
Kit presa di corrente 2P
Electric socket kit
Schuko/UNEL 16A+LAN

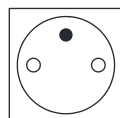

EQAC.ESC25
Kit presa di corrente FR 2P
Electric socket kit
+T13A + LAN

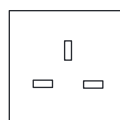

EQAC.ESC9
Kit presa di corrente UK 2P
Electric socket kit
+T13A + LAN

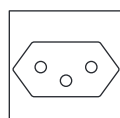

EQAC.ESC10
Kit presa di corrente SWISS 2P
Electric socket kit
+T13A + 1 LAN

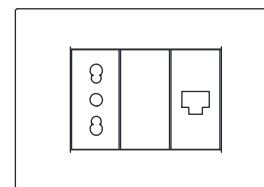

EQAC.ESC27
Kit presa di corrente universale civile
1 bipasso 16A+FALSOPOLO+LAN
Universal civil electric socket kit
1 bipasso 16A+FALSOPOLO+LAN

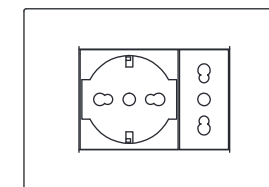

EQAC.ESC2
Kit presa di corrente universale civile
1 bipasso 16A+ 1 Schuko/UNEL 16A
Universal civil electric socket kit
1 bipasso 16A+ 1 Schuko/UNEL 16A



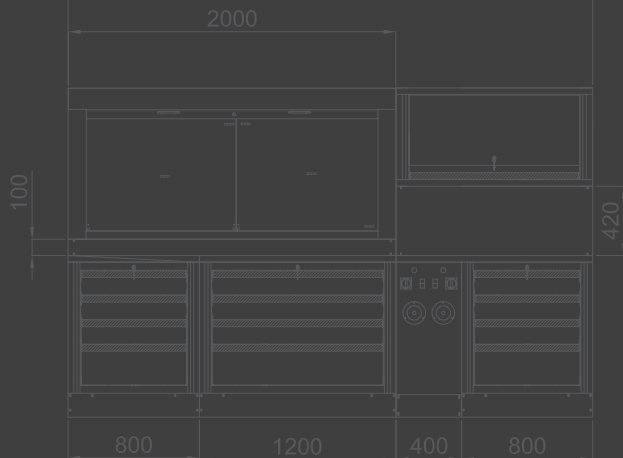

**SOLUZIONI DI ARREDO
MODULARE PER OFFICINA**

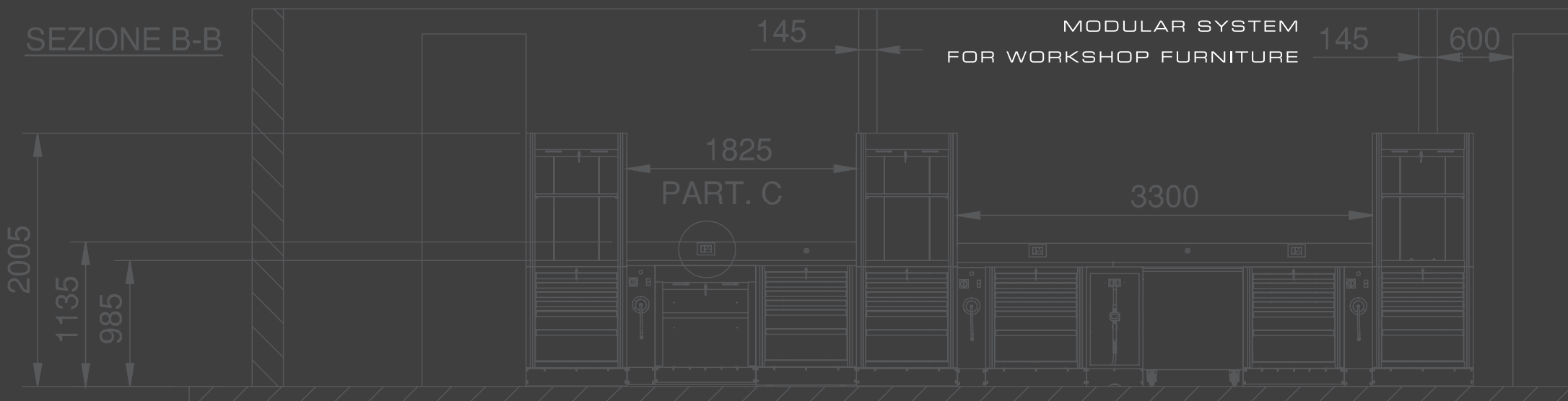

Brand of
FERRARI SERGIO METALMECCANICA S.R.L.
Via Peppone e Don Camillo, 11 - Z.I. Dugara
CAP 42041 - Brescello (Reggio Emilia) - ITALY
Ph. +39 0522 687907
Fax +39 0522 684498
www.lv8qube.it - info@lv8.it