

リビジョン				
バージョン	リビジョン	注記	日付	承認
	0	新規作成	20.02.05	

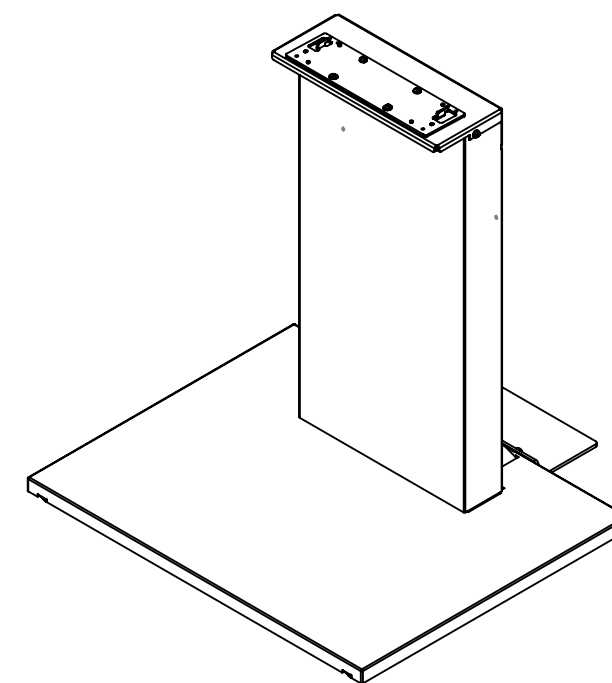

本体質量 : 22.3 ±1 Kg

THIRD ANGLE PROJECTION

MATERIAL

FINISH

DO NOT SCALE DRAWING

	NAME	DATE	ALPHATEC	
DRAWN	金子	20.02.05	TITLE:	
CHECKED			AZ502M-MK65-58	
ENG APPR.			SIZE	DWG. NO.
MFG APPR.			A3	AZ502M-6558
Q.A.			REV	0
COMMENTS:			SCALE: 1:10	SHEET 1 OF 1