

TITLE	片長ニップル
MODEL	R-7F-1/8 L=50

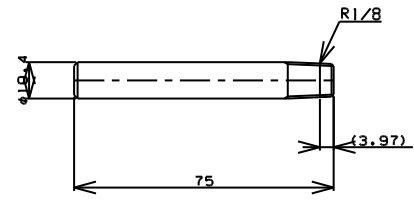

TITLE	片長ニップル
MODEL	R-7F-1/8 L=75

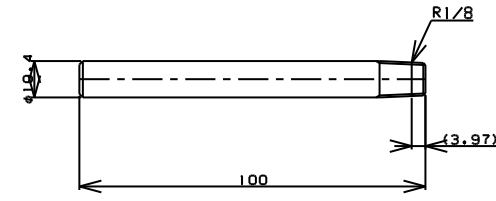

TITLE	片長ニップル
MODEL	R-7F-1/8 L=100

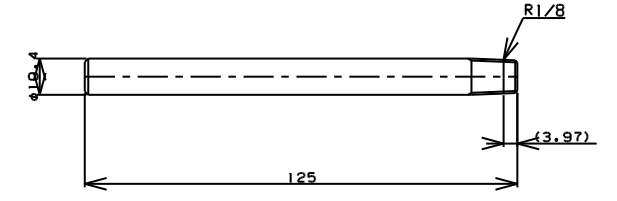

TITLE	片長ニップル
MODEL	R-7F-1/8 L=125

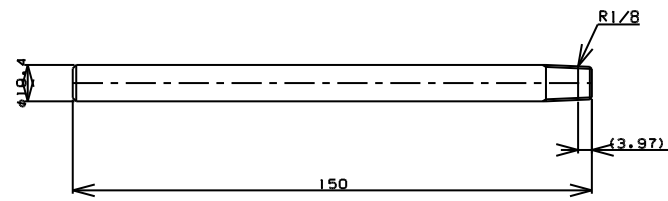

TITLE	片長ニップル
MODEL	R-7F-1/8 L=150

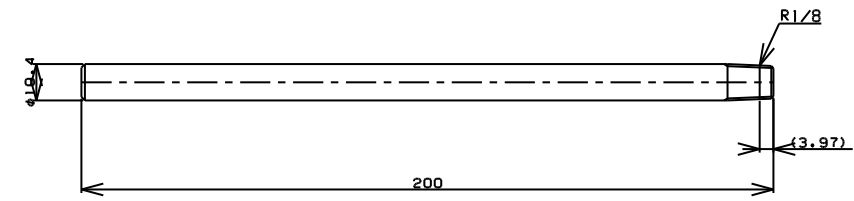

TITLE	片長ニップル
MODEL	R-7F-1/8 L=200

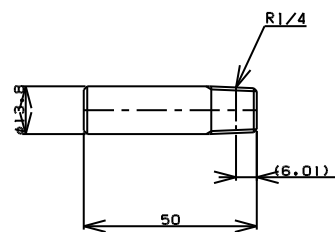

TITLE	片長ニップル
MODEL	R-7F-1/4 L=50

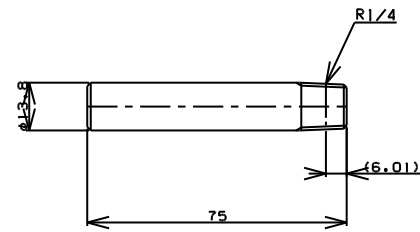

TITLE	片長ニップル
MODEL	R-7F-1/4 L=75

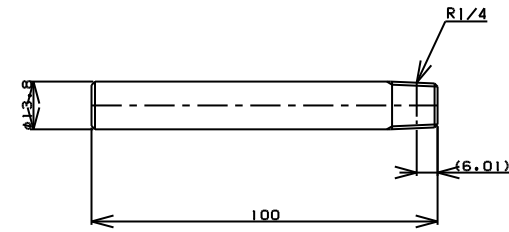

TITLE	片長ニップル
MODEL	R-7F-1/4 L=100

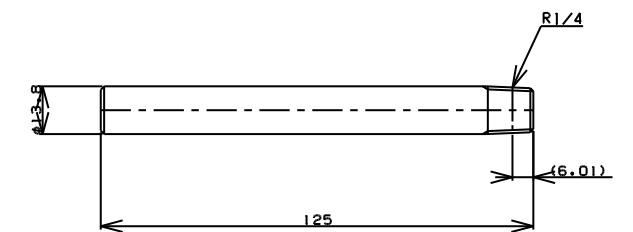

TITLE	片長ニップル
MODEL	R-7F-1/4 L=125

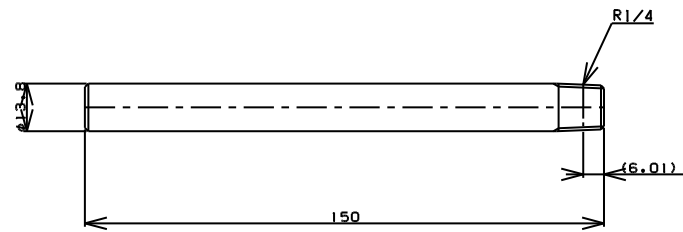

TITLE	片長ニップル
MODEL	R-7F-1/4 L=150

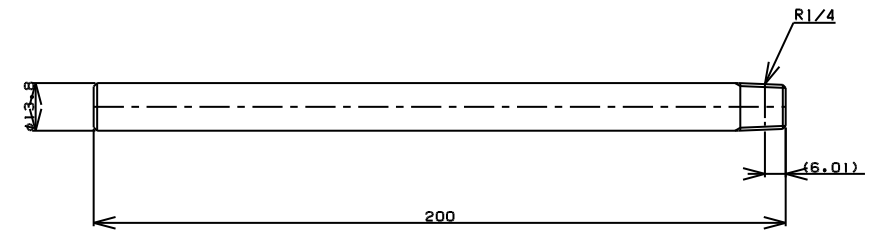

TITLE	片長ニップル
MODEL	R-7F-1/4 L=200

CAD DATA	RGL JOINT CO., LTD	
DATE	07, 4.11	1/1
	AI	

RGL JOINT

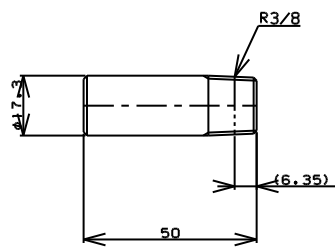

TITLE	片長ニップル
MODEL	R-7F-3/8 L=50

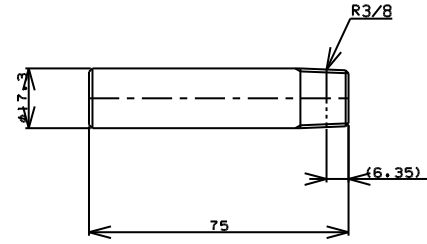

TITLE	片長ニップル
MODEL	R-7F-3/8 L=75

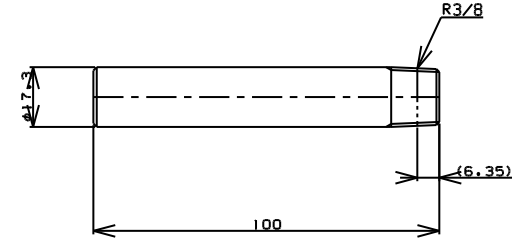

TITLE	片長ニップル
MODEL	R-7F-3/8 L=100

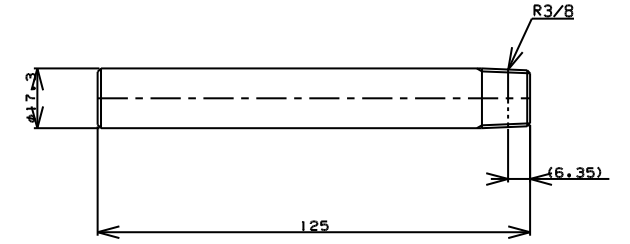

TITLE	片長ニップル
MODEL	R-7F-3/8 L=125

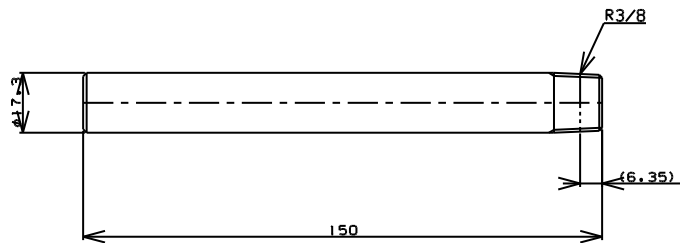

TITLE	片長ニップル
MODEL	R-7F-3/8 L=150

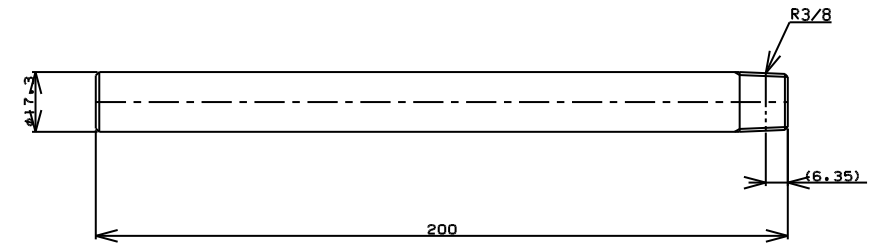

TITLE	片長ニップル
MODEL	R-7F-3/8 L=200

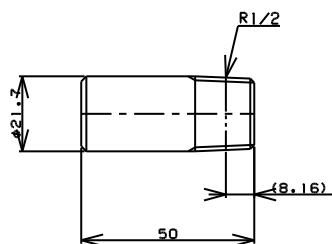

TITLE	片長ニップル
MODEL	R-7F-1/2 L=50

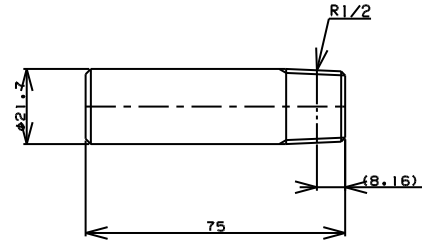

TITLE	片長ニップル
MODEL	R-7F-1/2 L=75

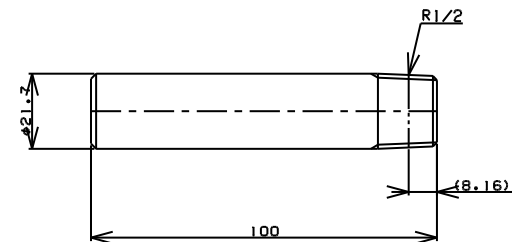

TITLE	片長ニップル
MODEL	R-7F-1/2 L=100

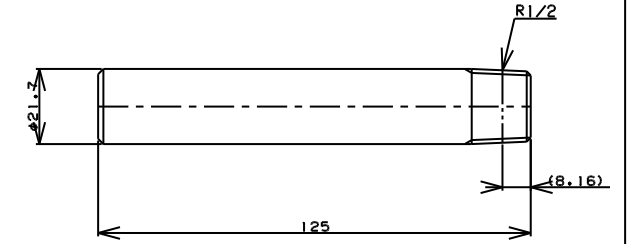

TITLE	片長ニップル
MODEL	R-7F-1/2 L=125

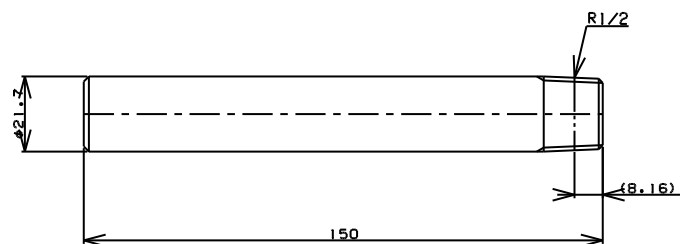

TITLE	片長ニップル
MODEL	R-7F-1/2 L=150

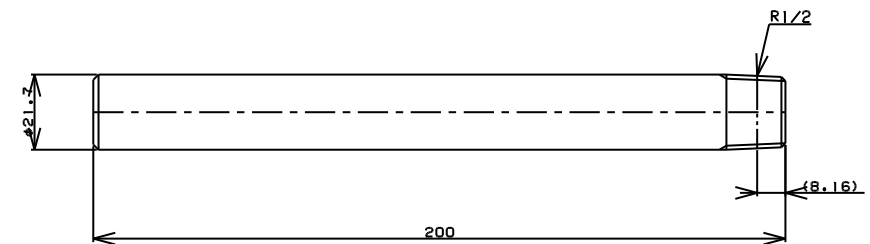

TITLE	片長ニップル
MODEL	R-7F-1/2 L=200

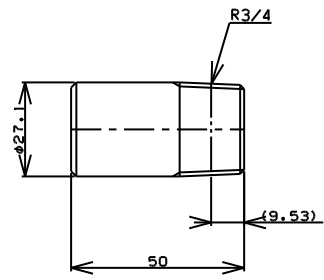

TITLE	片長ニップル
MODEL	R-7F-3/4 L=50

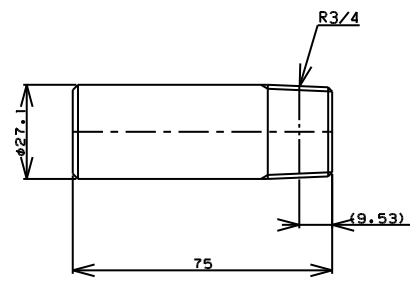

TITLE	片長ニップル
MODEL	R-7F-3/4 L=75

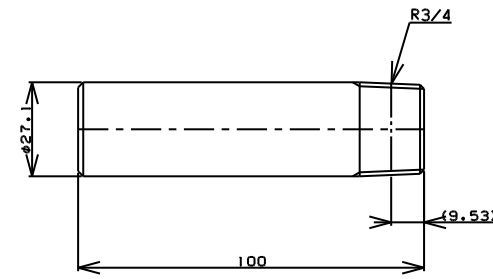

TITLE	片長ニップル
MODEL	R-7F-3/4 L=100

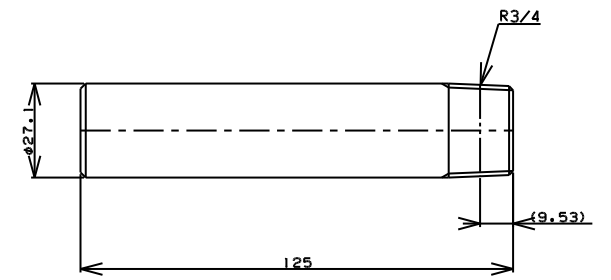

TITLE	片長ニップル
MODEL	R-7F-3/4 L=125

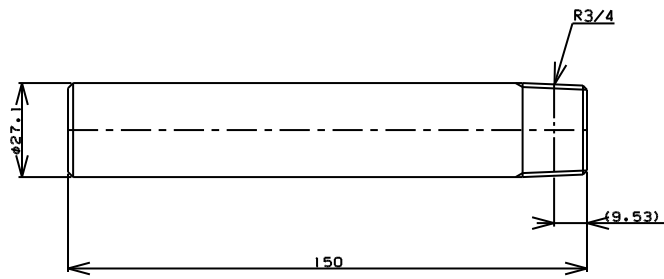

TITLE	片長ニップル
MODEL	R-7F-3/4 L=150

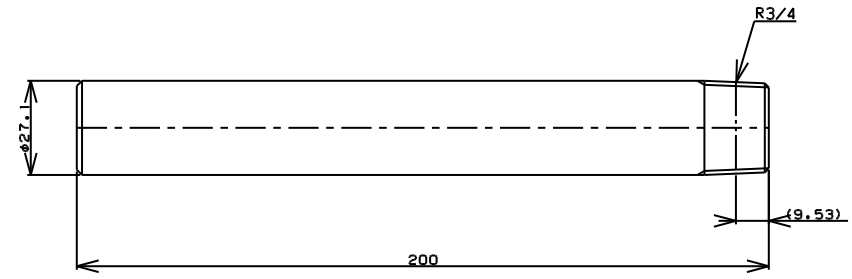

TITLE	片長ニップル
MODEL	R-7F-3/4 L=200

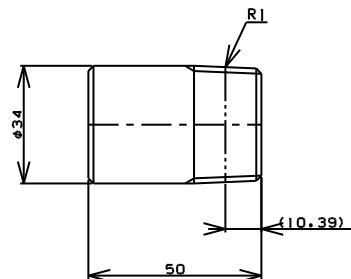

TITLE	片長ニップル
MODEL	R-7F-1 L=50

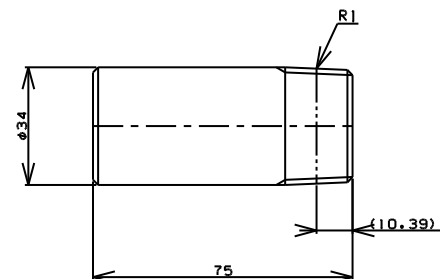

TITLE	片長ニップル
MODEL	R-7F-1 L=75

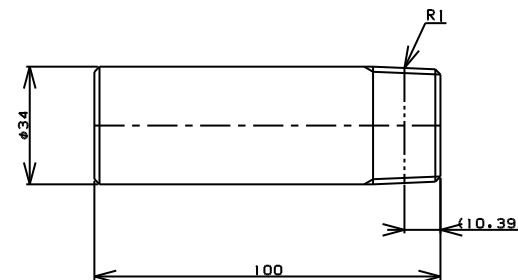

TITLE	片長ニップル
MODEL	R-7F-1 L=100

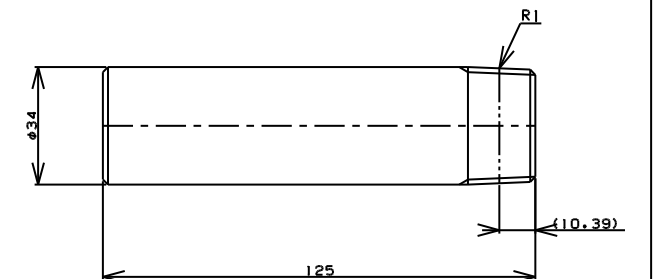

TITLE	片長ニップル
MODEL	R-7F-1 L=125

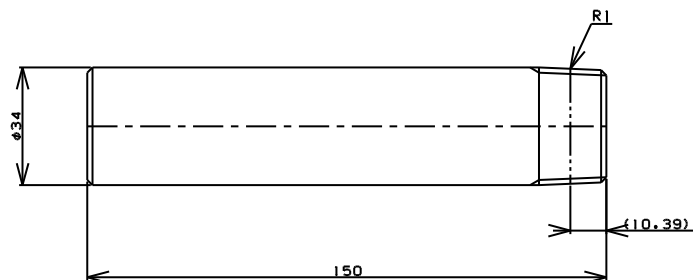

TITLE	片長ニップル
MODEL	R-7F-1 L=150

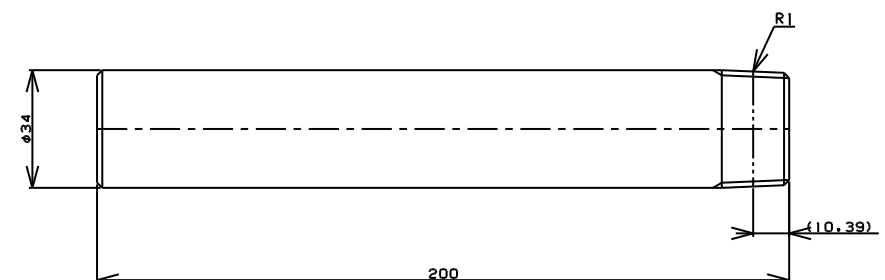

TITLE	片長ニップル
MODEL	R-7F-1 L=200

CAD DATA	RGL JOINT CO., LTD
DATE 07, 4.11	AI 1/1

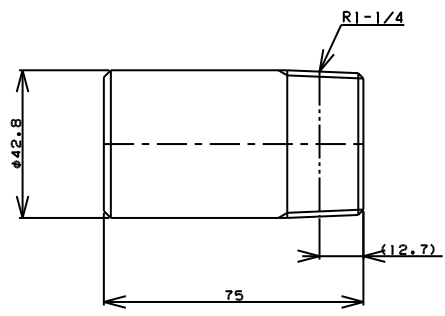

TITLE	片長ニップル
MODEL	R-7F-1-1/4 L=75

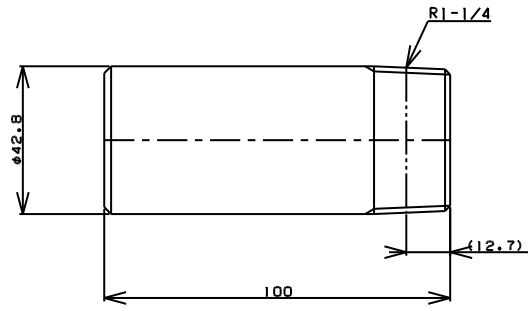

TITLE	片長ニップル
MODEL	R-7F-1-1/4 L=100

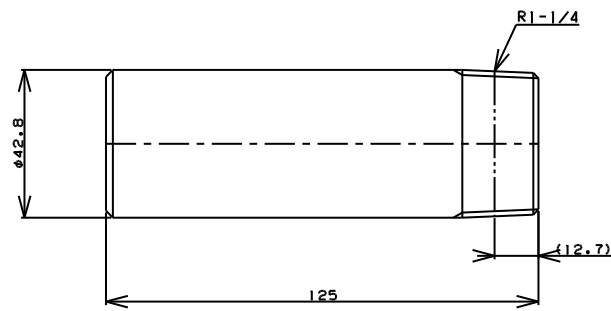

TITLE	片長ニップル
MODEL	R-7F-1-1/4 L=125

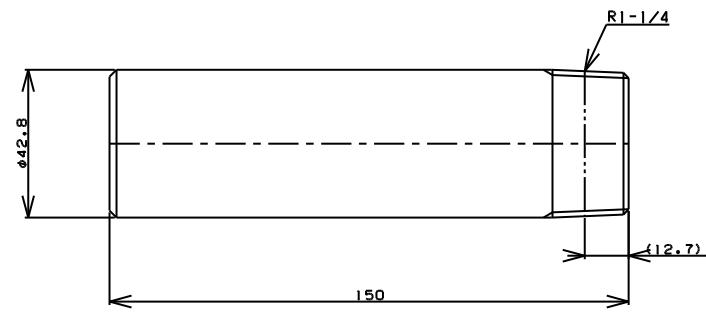

TITLE	片長ニップル
MODEL	R-7F-1-1/4 L=150

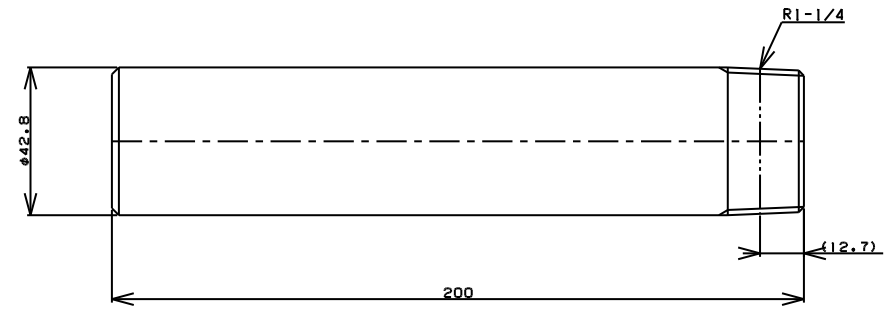

TITLE	片長ニップル
MODEL	R-7F-1-1/4 L=200

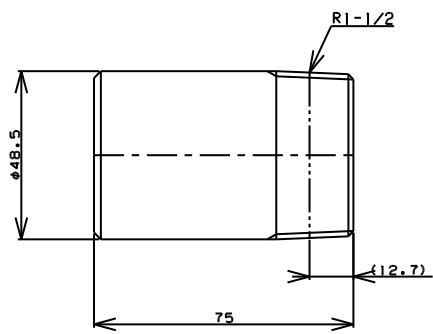

TITLE	片長ニップル
MODEL	R-7F-1-1/2 L=75

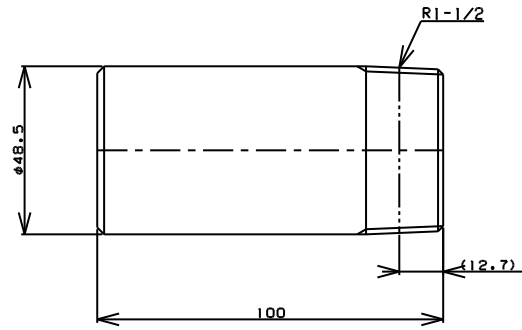

TITLE	片長ニップル
MODEL	R-7F-1-1/2 L=100

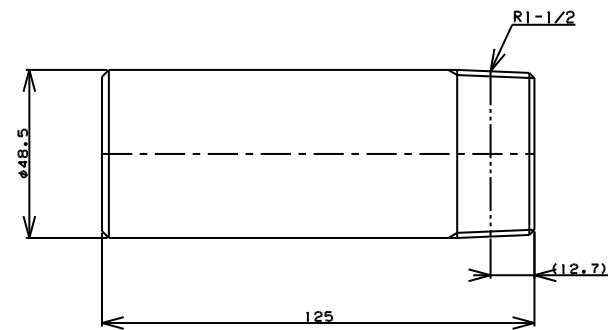

TITLE	片長ニップル
MODEL	R-7F-1-1/2 L=125

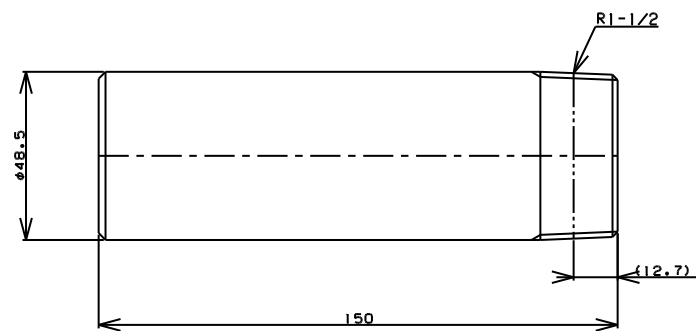

TITLE	片長ニップル
MODEL	R-7F-1-1/2 L=150

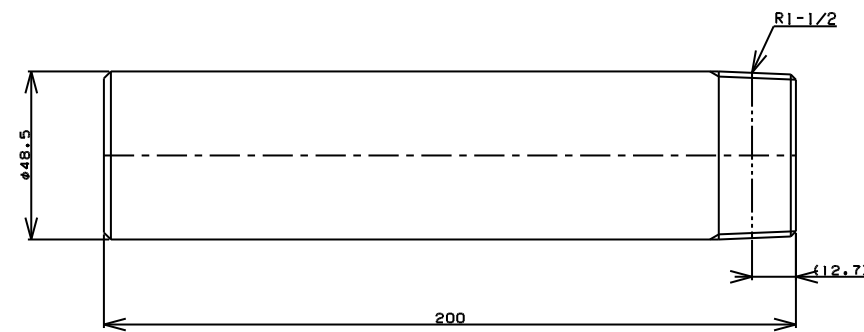

TITLE	片長ニップル
MODEL	R-7F-1-1/2 L=200

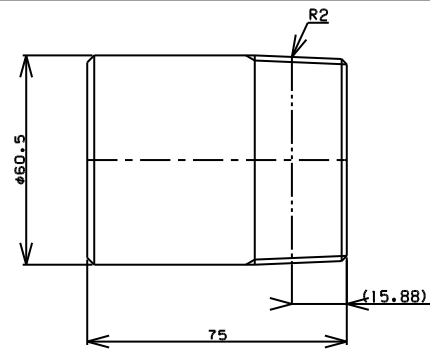

TITLE	片長ニップル
MODEL	R-7F-2 L=75

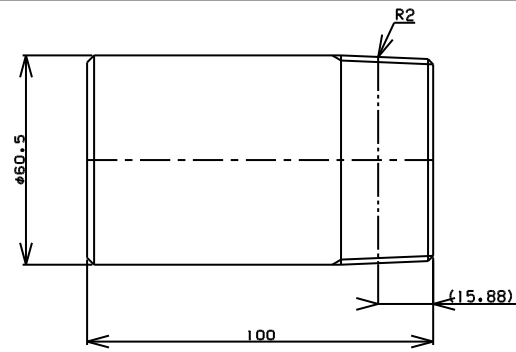

TITLE	片長ニップル
MODEL	R-7F-2 L=100

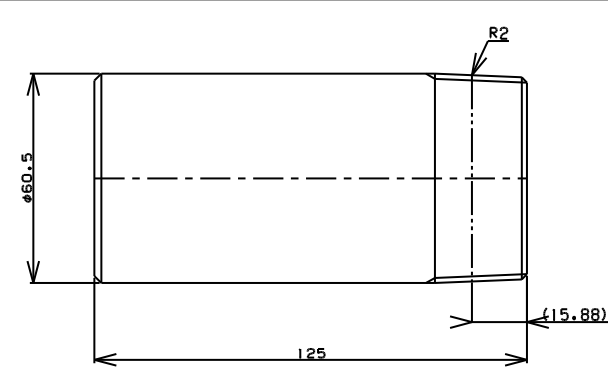

TITLE	片長ニップル
MODEL	R-7F-2 L=125

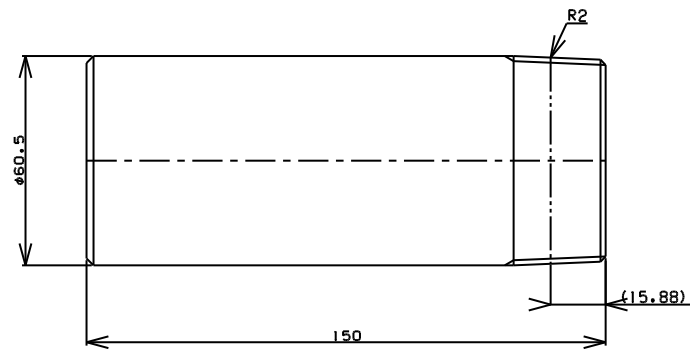

TITLE	片長ニップル
MODEL	R-7F-2 L=150

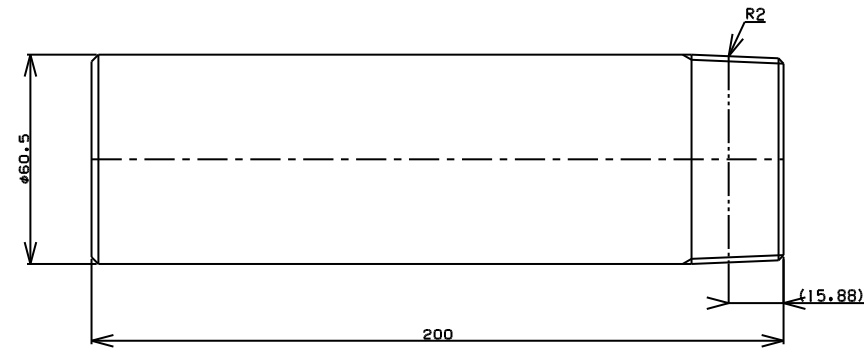

TITLE	片長ニップル
MODEL	R-7F-2 L=200