

TITLE	KADOMIRESS KANTOUCH
MODEL	TH8-1/4-B-N-R _o

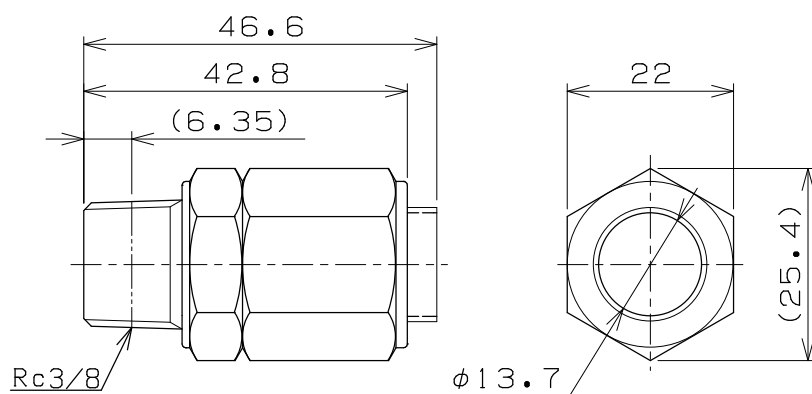

TITLE	KADOMIRESS KANTOUCH
MODEL	TH8-3/8-B-N-R _o

TH8-B-N-R _o	RGL JOINT CO., LTD		
DATE	08, 02, 29	A4	1/1